



YRB-A<sup>®</sup>  
A d v a n c e

# What is YRB-A?

Y of YKK / R of Rain / B of Barrier / A of Advance

## 新研發耐颶水密結構

頂級水密性能

**1500Pa**

— 2250Pa最大值 —



# 住宅品質新基準

創造高超水密 成就完美空間

現代消費者購置住宅標準逐漸提升，建材的品質、性能、保護地球環境及附加價值等各式各樣的要求也日益增加。YKK AP為提供更舒適的生活空間，始終以日本最高標準自我要求，持續開創卓越新標準。同時更積極拓展商品多樣性，以回應消費者之需求為使命，為台灣消費者的高品質生活貢獻心力。

YKK新水密結構品質  
高於日本國家標準  
直達3倍

高規格生活水密，  
嚴守您的居家品質

台灣地處亞熱帶，屬海島型潮濕氣候，經年累月的強風豪雨，易造成雨水經由鋁窗滲入室內的情形。因應這樣的嚴苛氣候條件，YKK AP應用等氣壓理論，獨自研發出新水密結構，通過1500Pa水壓測試，以遠超過JIS基準的「高水密性」\*持續自我要求。即使在長時間的暴風雨中，也能讓雨水不易滲透，實現理想中的「生活水密」。

\*「水密性」是指在風雨中，門窗能抵抗多大的風壓，以防止雨水滲入室內的性能。

家，  
是每個人一談到，  
就立刻感到溫暖安心的地方。  
當你我置身其中，  
透過一扇窗，  
我們什麼也不會錯過，  
依然看得見窗外的世界，  
恣意領略四季的溫柔、狂暴、熱情與憂傷；  
那扇窗，  
讓後方的我們安然保存了  
內在的寧靜、溫暖和爽朗，  
不受外在影響。



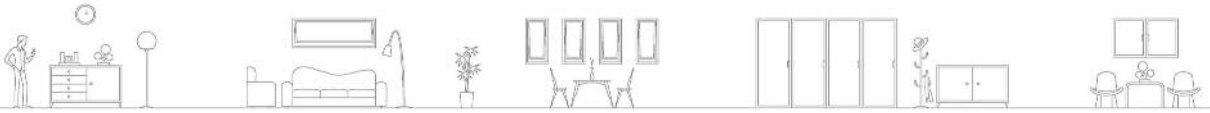

Pleasant

## 水密性能提升·確保安心生活

### CNS·JIS水密性能與等級

水密性之等級與性能 .....

JIS A 4706:2000·JIS A 4702:2000中規定水密性等級如下表。  
YRB-A70/YRB-A100確保高達1500 Pa的水密性，遠超過JIS判定基準最高等級之W-5 <500Pa>。

等級	W-1	W-2	W-3	W-4	W-5	
壓力差 (脈動壓中央值)	Pa	100	150	250	350	500

JIS及CNS基準之水密試驗方法 .....

JIS A 1517規定建築門窗之水密性試驗方法。試驗方法如下圖所示，將鉛門窗組安裝在壓力箱上，每分鐘噴射4L/m<sup>2</sup>·min的水，施加10分鐘的脈動壓，觀察試驗中鉛門窗組的漏水狀況。

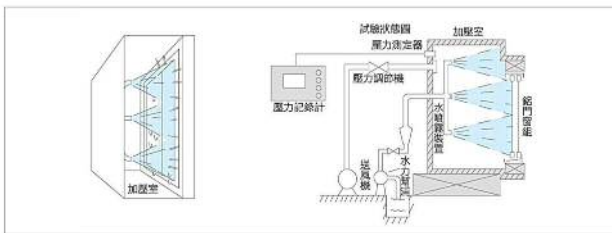

### 嚴苛氣候下，確保「生活水密」，守護生活環境

生活水密確認試驗 .....

以台灣嚴苛氣候條件，特別是颱風長時間滯留時為假想值，進行嚴格試驗。施加10分鐘中央值1500 Pa的水密壓力，確認其水密性，不會對生活帶來危害。這就是YKK AP的【生活水密】(YKK AP獨家開發基準)

水密性1500 Pa-10分鐘·1000 Pa-180分鐘 .....



### 新等壓結構 確保高水密性

應用新等氣壓構造 .....

等氣壓理論的原理，是讓下窗框或外框直料與內扇疊合處內的壓力，約等同於外氣壓力，如此便能將雨滴的動能，封殺在滴水線，以確保高水密性。YKK AP便應用了這個理論，開發出獨自的新水密構造，讓YRB-A70/YRB-A100實現了前所未有的更高水密性。

#### A 窗扇疊合部

創新結構設計，增強水密性能至1500Pa，防止強風夾帶豪雨侵入，僅讓外氣流通形成等壓空間，確保安心生活。

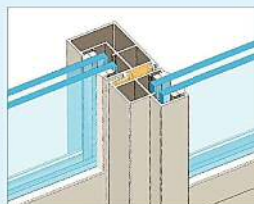

#### B 下窗框&內窗扇

縮小下窗框、下門框的空隙，抑制雨水由外部滲入。在下框中空處設置外氣導入流路，形成等壓空間。

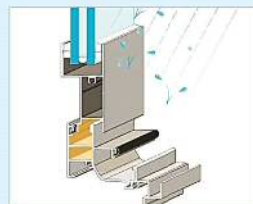

#### C 下窗框&外窗扇

在高於外窗扇軌道的位置，裝設氣密材，並且在下框中空處，設置外氣導入流路，形成等壓空間。

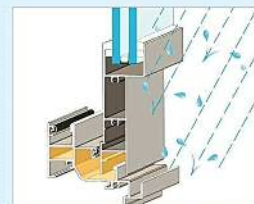

■ 等壓空間



View

## 極致線條美學 · 創造開闊視野

窗框線條細緻化 工藝美學極致展現

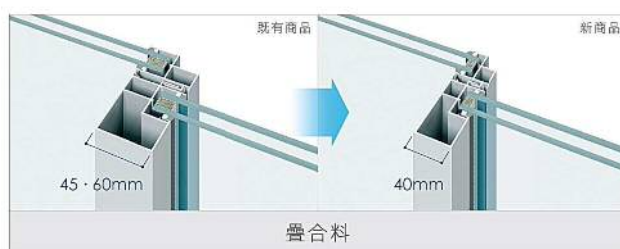

Noise

## 有效隔絕噪音 · 安享舒適空間

日常生活情境分貝對照表

噪音等級 dB(A)	30	40	50	60	70	80	90
噪音環境							
噪音感覺	安靜	日常生活理想範圍		吵雜		極度吵雜	

出色的隔音效果

即使在都市·幹線道路沿線，也可確保舒適的生活空間。



\* 依玻璃厚度及種類不同，隔音效果不一。  
\* 一般來說日常生活中較合宜的噪音程度60dB~40dB。

商品體系

水密性高達1500Pa，遠超過JIS以及CNS基準最高等級之500Pa，再加上性能高達T-2·T-3的高隔音效果，構成舒適的生活空間。

		隔音效果	
		T-2 <30等級>	T-3 <35等級>
水密性			
1500 Pa	▶	YRB-A70 YRB-A100	YRB-A70 YRB-A100
1000 Pa	▶		
500 Pa	▶		

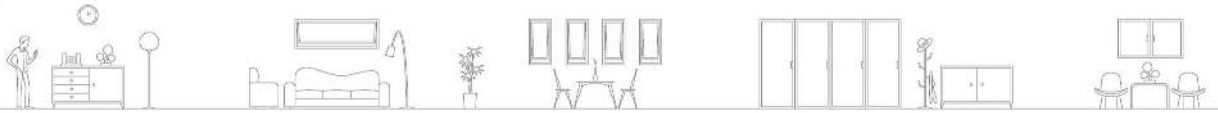

Security

## 安心安全設計 · 守護居住天地

橫拉窗(限開開關) ..... 推開窗(限開開關) ..... 內扇保護設計 .....

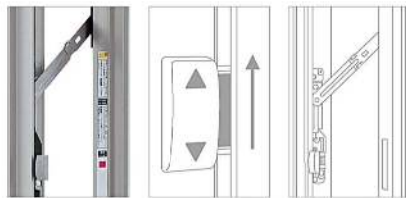
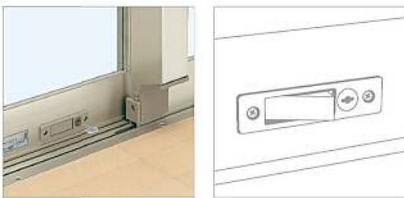

紗窗防脫落裝置 ..... 新型捲筒式紗窗 ..... 重型滾輪 .....

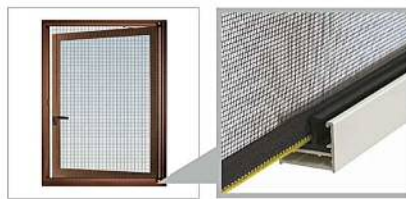
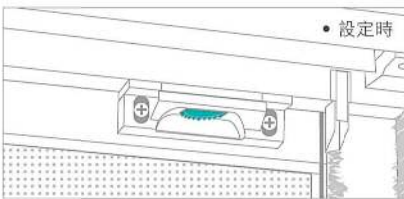

獨創滑輪設計，確保使用順暢。

\*註：設定滾輪耐荷重時請先行確認玻璃重量。



Reform

## 人體工學設計 · 絕佳舒適手感

標準部品 ..... 其他選購配備 .....

推開窗系



輔助把手



橫拉窗系



氣密門用



其他把手 · 窗扣



\*註：另有其他標準色部品可供選配。

## 商品規格表

YRB-A	YRB-A70				YRB-A100			
	玻璃開口/mm	水密(pa)	氣密	風壓(pa)	玻璃開口/mm	水密(pa)	氣密	風壓(pa)
橫拉窗	16、22、28、36	1500	2	3600	16、22、28、36	1500	2	3600
單拉窗	16、22、28				16、22、28			
推開窗	18、22、28、36				18、22、28、36			
推射窗	18、22、28、36				18、22、28、36			
固定窗	18、22、28、36、42				18、22、28、36、42			
氣密門	-				18、22、28、36			

## 窗型總覽

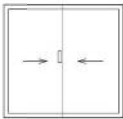
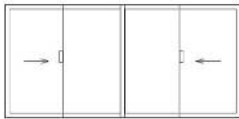
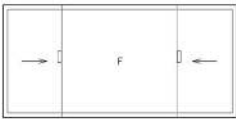
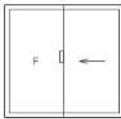
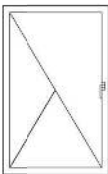
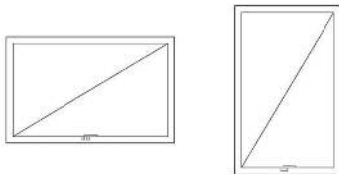
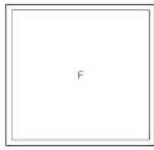
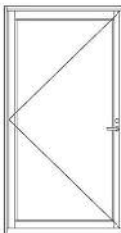
橫拉窗		雙橫拉真固定		單拉窗
2扇	4扇			
				
推開窗	推射窗		固定窗	氣密門
				

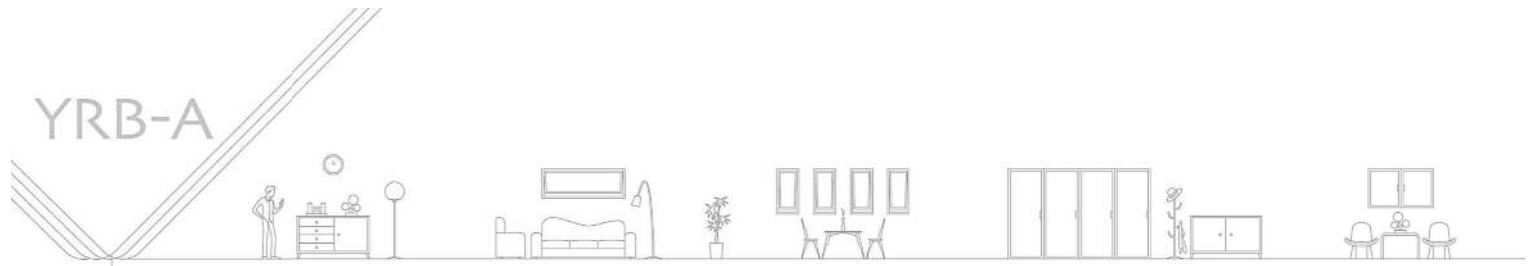

製作範圍表

橫拉窗2扇

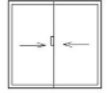

玻璃開口16mm溝槽

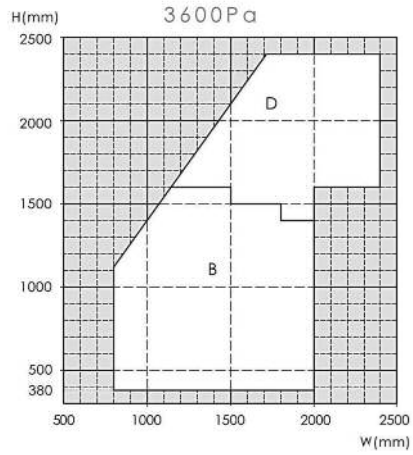
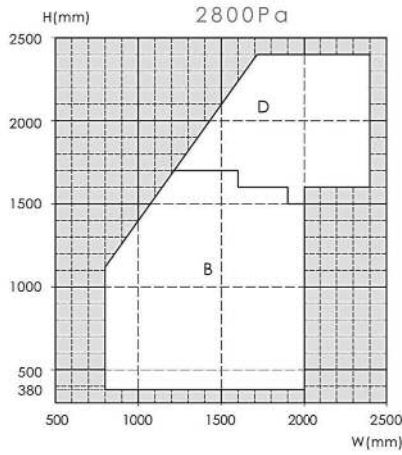

玻璃開口22mm溝槽

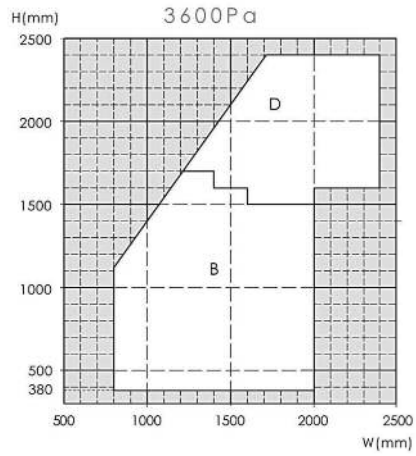
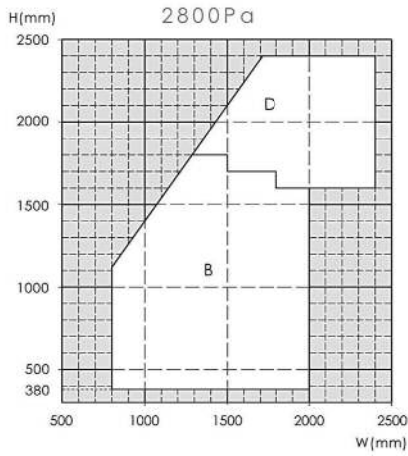

玻璃開口28,36mm溝槽

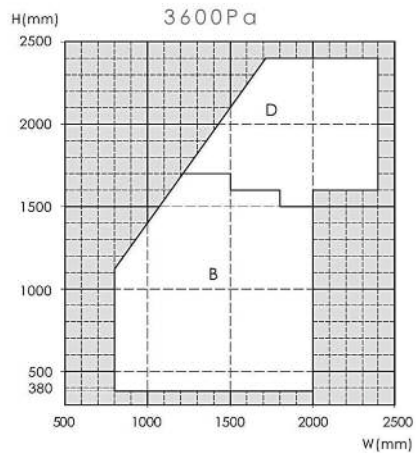
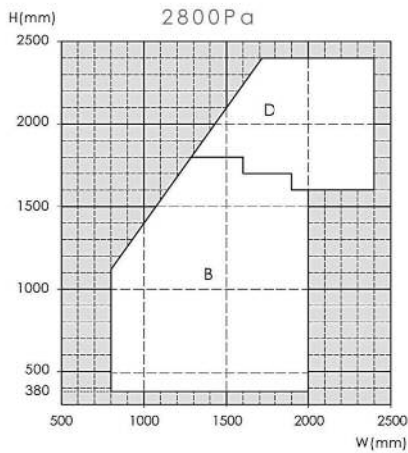

\* 本製作範圍表係依據窗框強度。\* 使用玻璃厚度不同，可能有無法製作之尺寸。請另行確認玻璃強度。



### 橫拉窗4扇

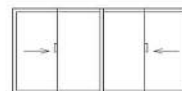

玻璃開口16mm溝槽

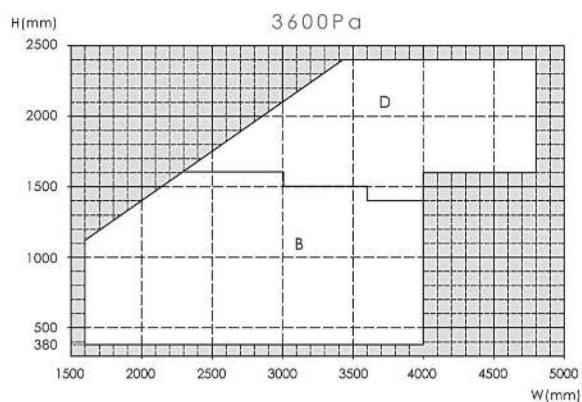
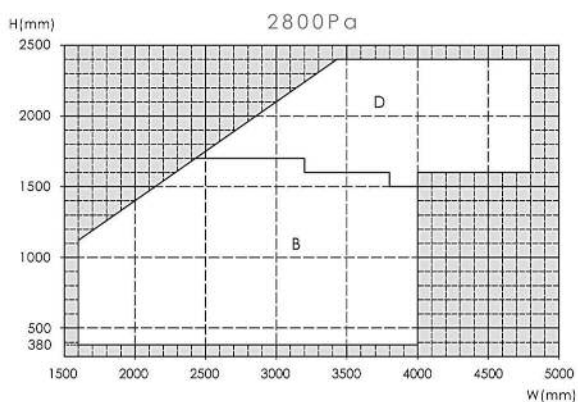

玻璃開口22mm溝槽

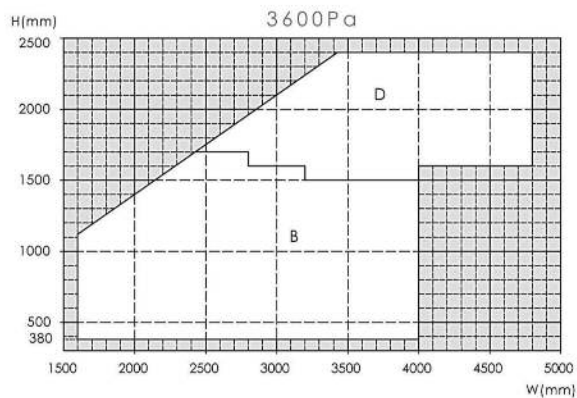
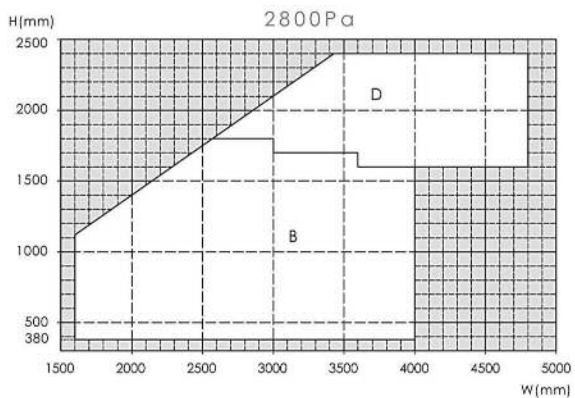

玻璃開口28,36mm溝槽

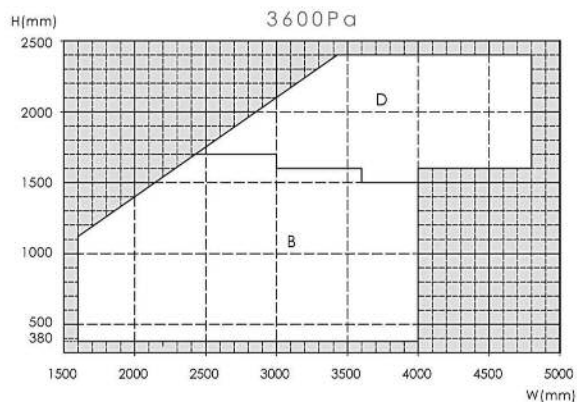
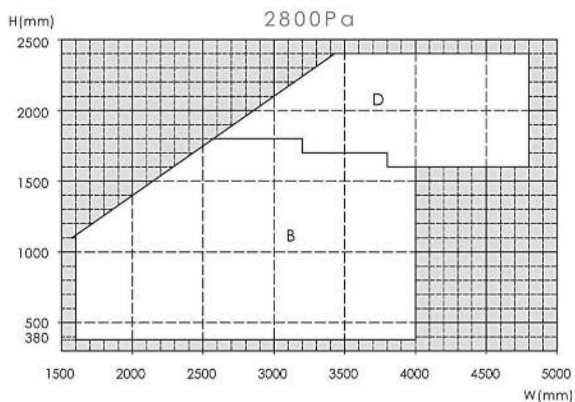

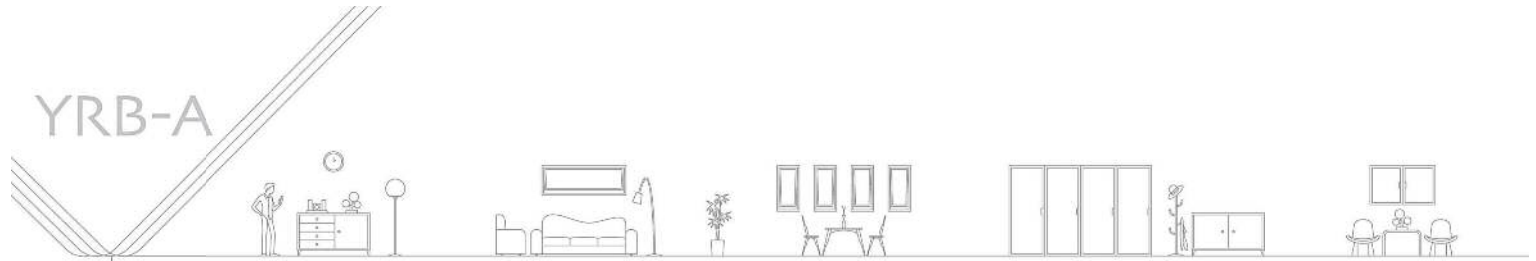

製作範圍表

雙橫拉真固定

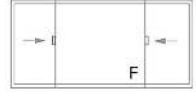

玻璃開口16mm 固定扇18mm溝槽

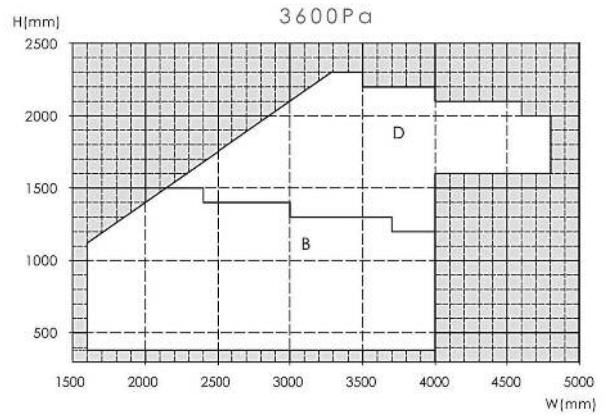
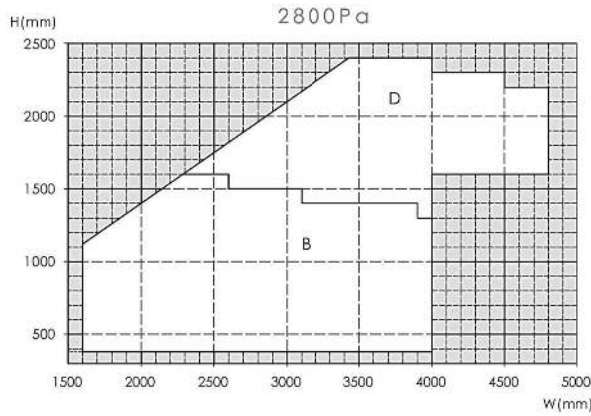

玻璃開口22mm溝槽

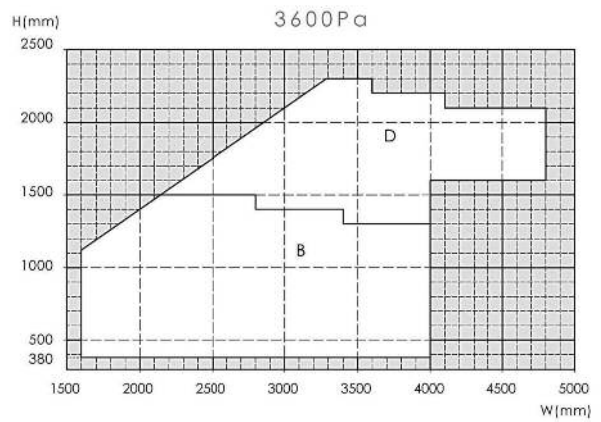
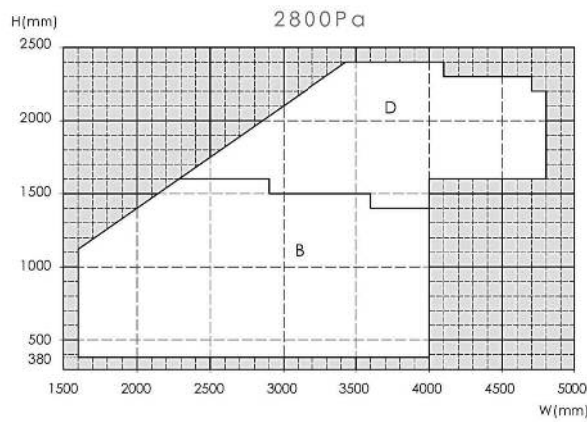

玻璃開口28,36mm溝槽

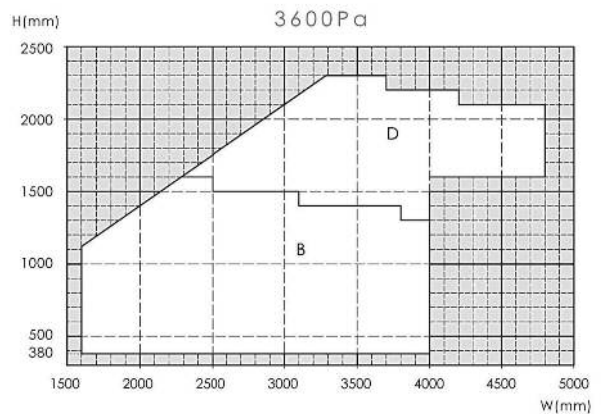
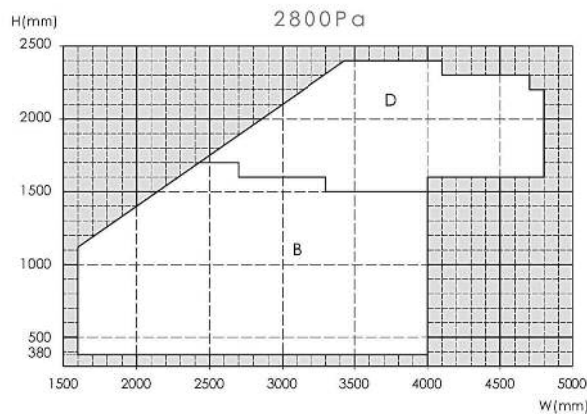

\* 本製作範圍表係依據窗框強度。\* 使用玻璃厚度不同，可能有無法製作之尺寸。請另行確認玻璃強度。



推開窗 (連動/單扣點) ..... 玻璃開口18、22、28、36mm溝槽.....

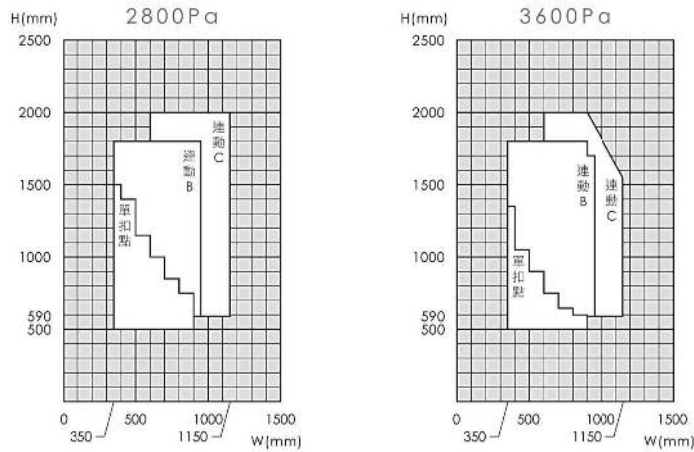

推射窗 (連動/單扣點) ..... 玻璃開口18、22、28、36mm溝槽.....

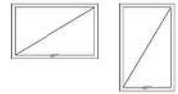
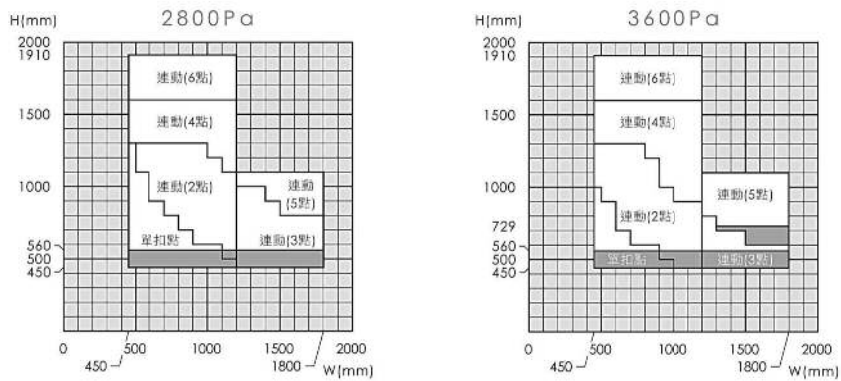

\*註：■深灰色標示處無法加裝定位桿。

氣密門 ..... 玻璃開口18、22、28、36mm溝槽.....

單開



雙開

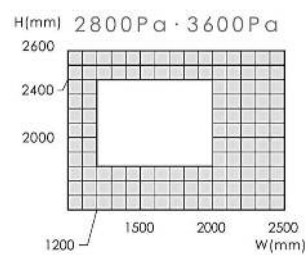
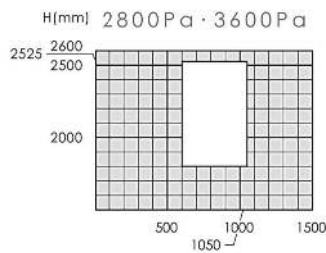

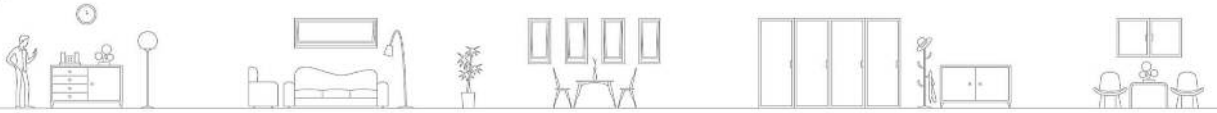

## 基本剖面圖

RC框型 YRB-A70 / 2扇橫拉窗B型 / 16mm溝寬

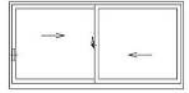
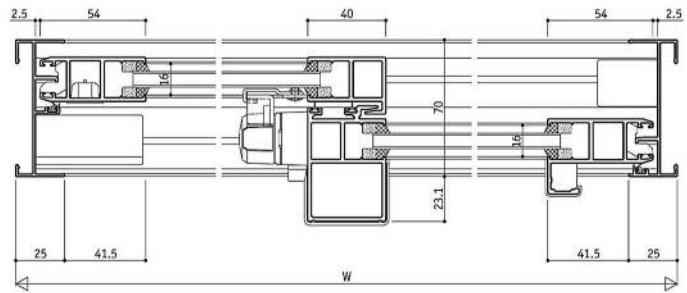
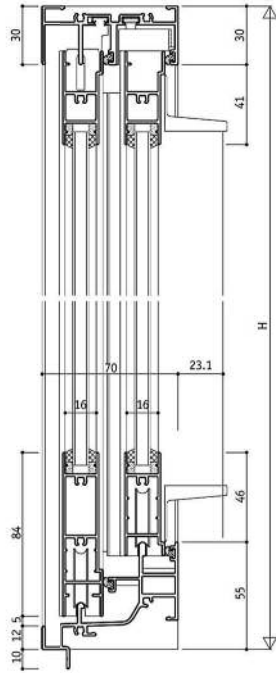

RC框型 YRB-A100 / 2扇橫拉窗D型 / 16mm溝寬

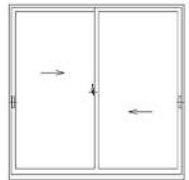
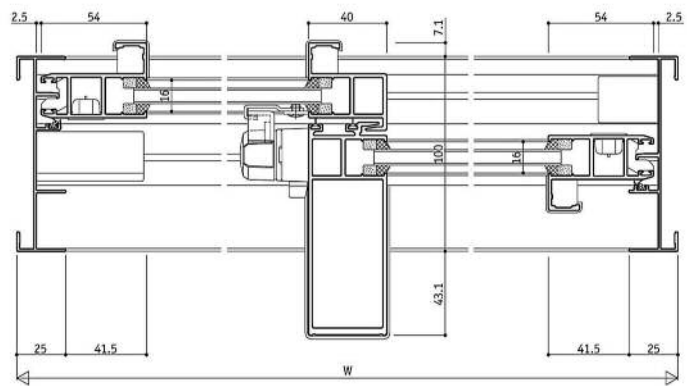
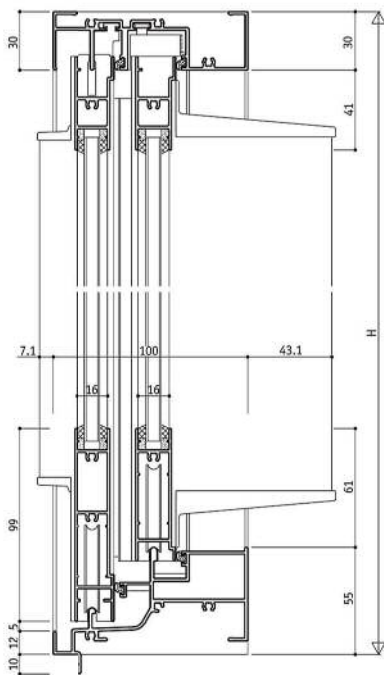



RC框型 YRB-A70/2扇橫拉窗B型/22mm溝寬

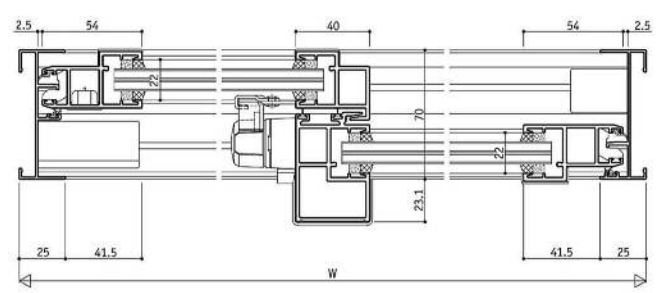
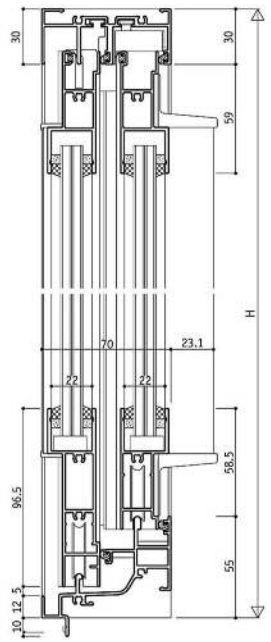
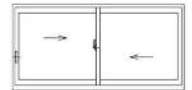

RC框型 YRB-A100/2扇橫拉窗D型/22mm溝寬

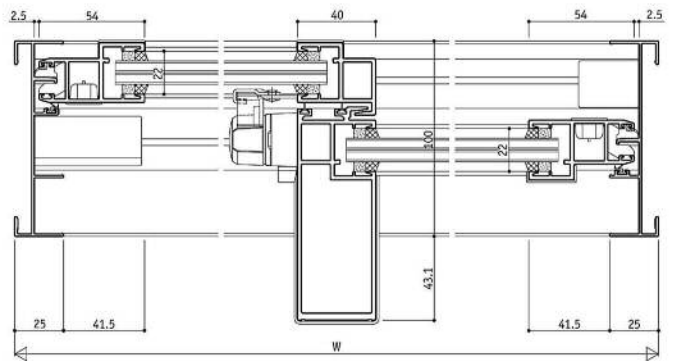
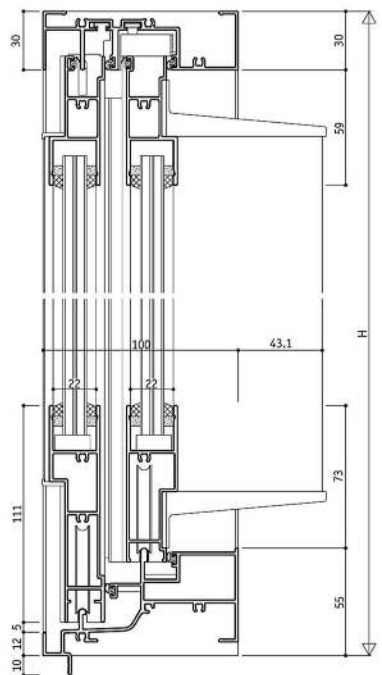
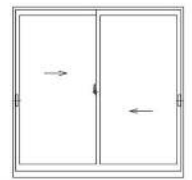



## 基本剖面圖

RC框型 YRB-A70 / 2扇橫拉窗B型 / 28mm溝寬

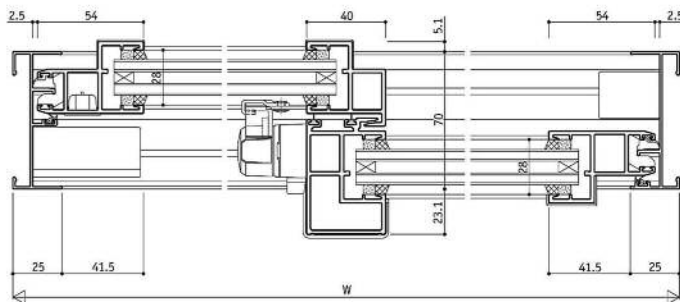
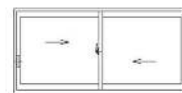
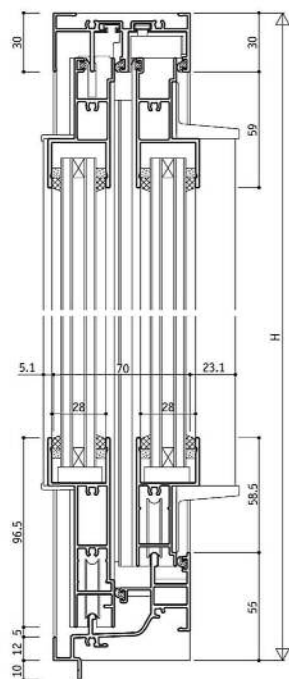

RC框型 YRB-A100 / 2扇橫拉窗D型 / 28mm溝寬

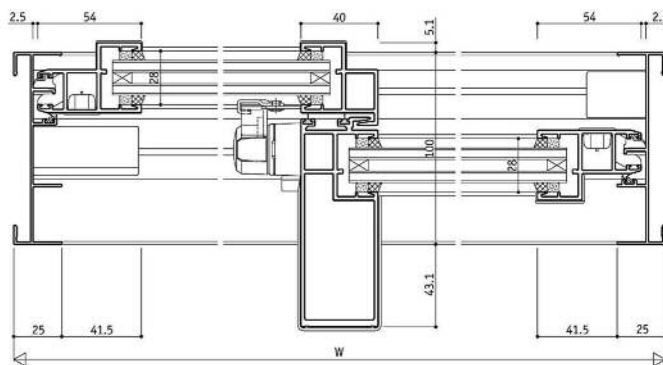
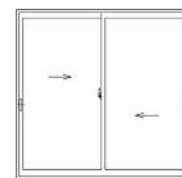
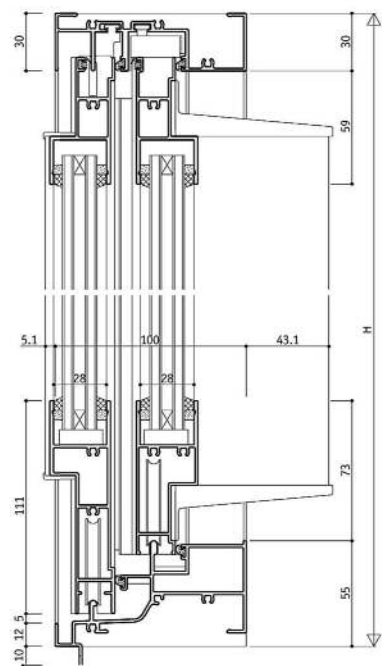



RC框型 YRB-A70 / 2扇横拉窗B型 / 36mm溝寬

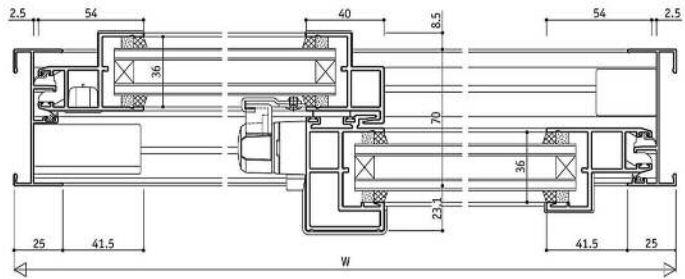
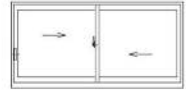
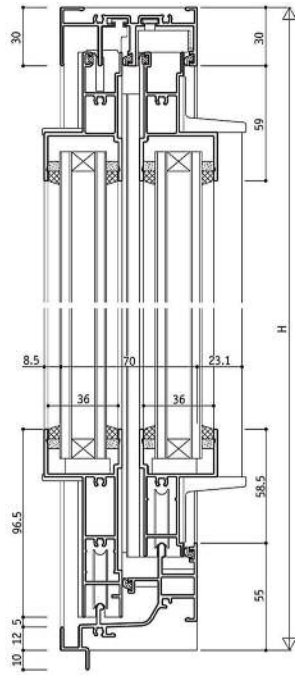

RC框型 YRB-A100 / 2扇横拉窗D型 / 36mm溝寬

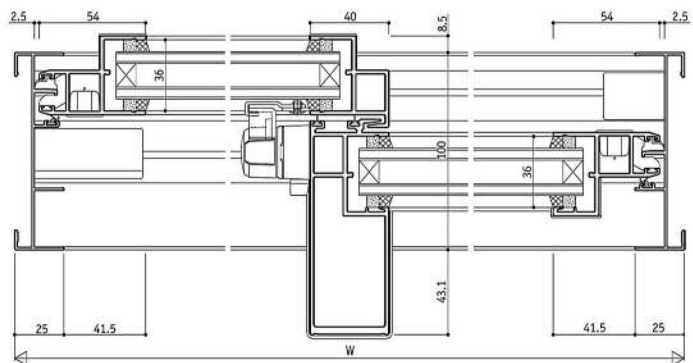
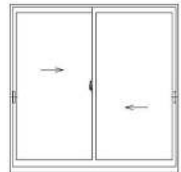
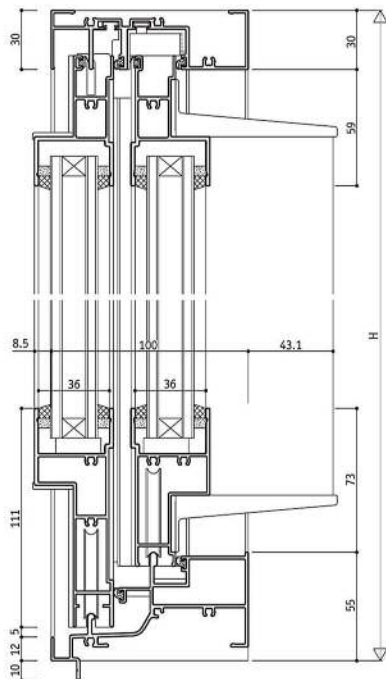



## 基本剖面圖

RC框型 YRB-A70/4扇橫拉窗B型/16mm溝寬

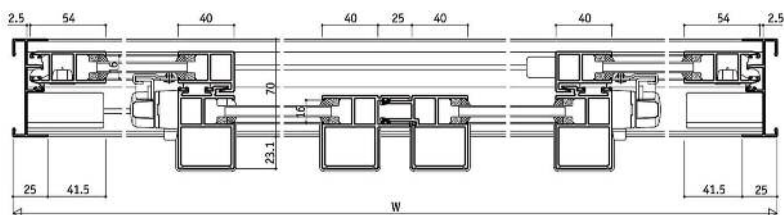
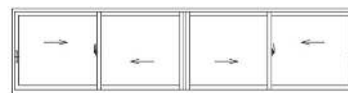
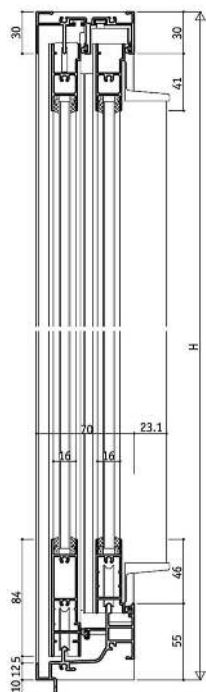

RC框型 YRB-A100/4扇橫拉窗D型/16mm溝寬

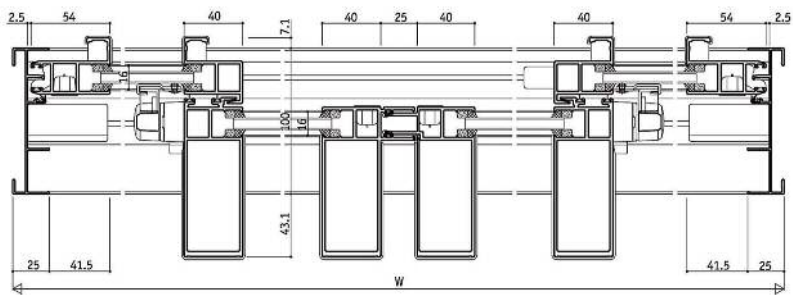
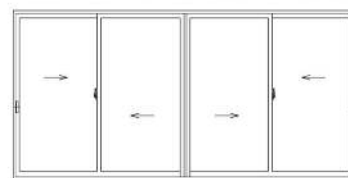
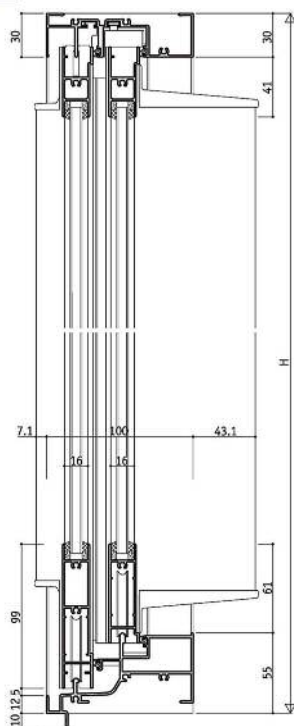

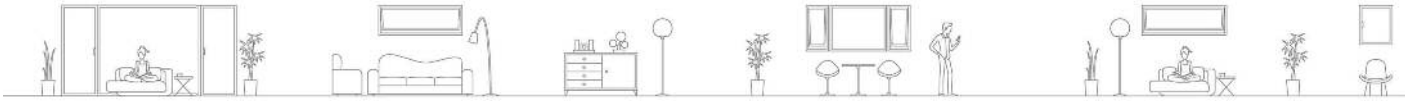

RC框型 YRB-A70/4扇橫拉窗B型/22mm溝寬

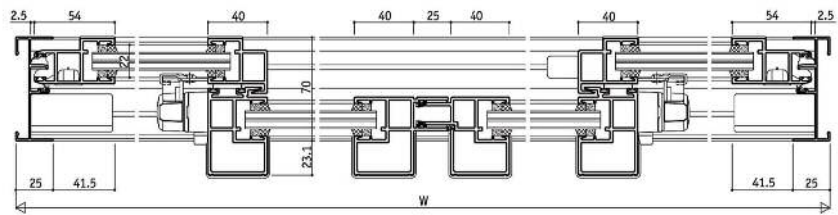
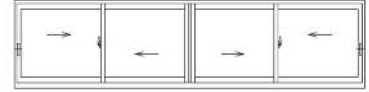
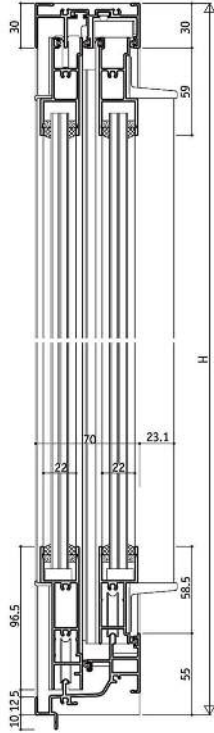

RC框型 YRB-A100/4扇橫拉窗D型/22mm溝寬

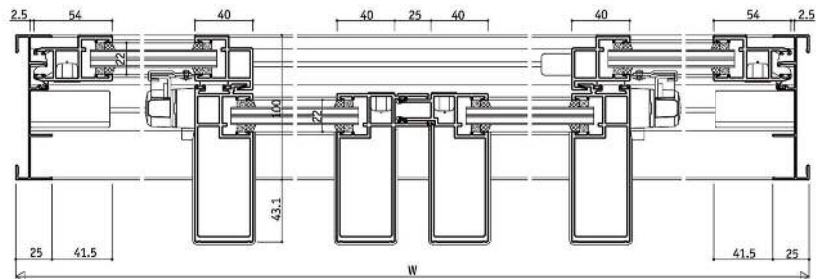
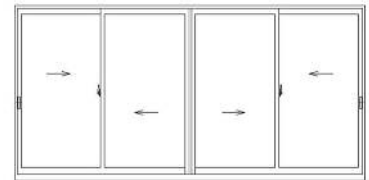
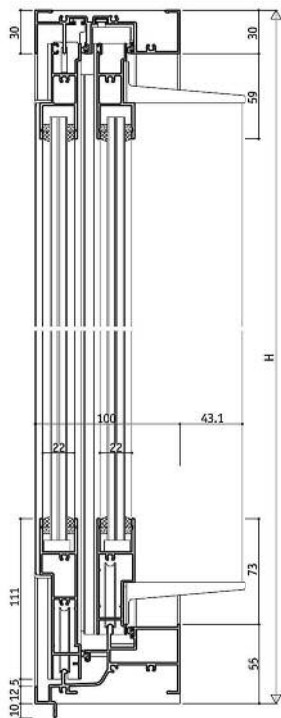

基本剖面圖

RC框型 YRB-A70/4扇橫拉窗B型/28mm溝寬

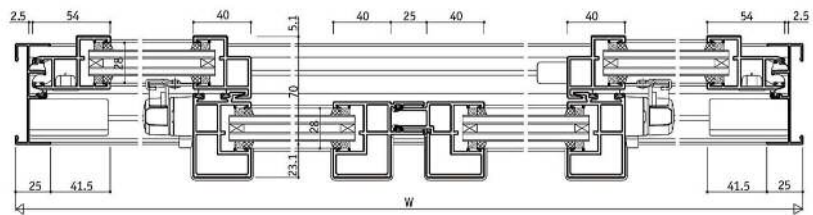
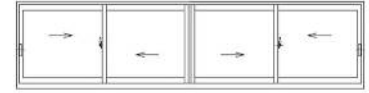
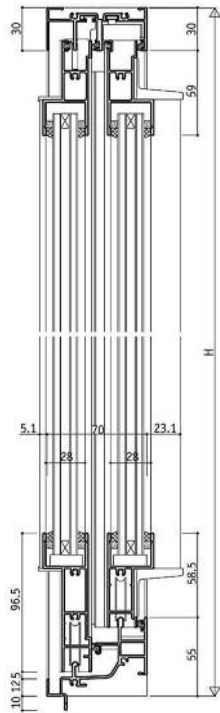

RC框型 YRB-A100/4扇橫拉窗D型/28mm溝寬

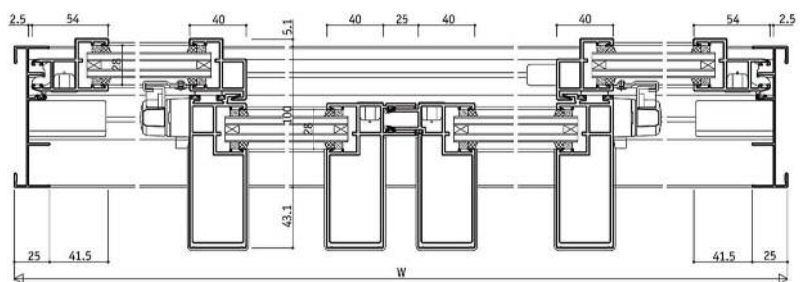
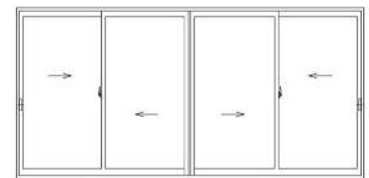
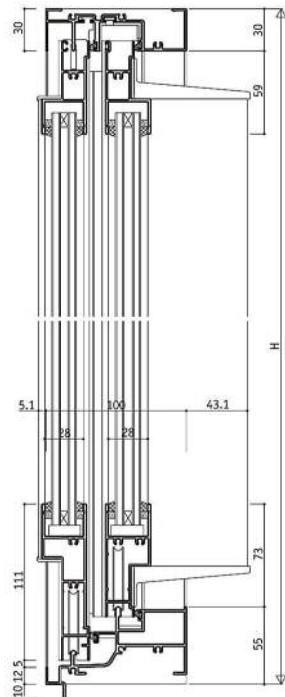



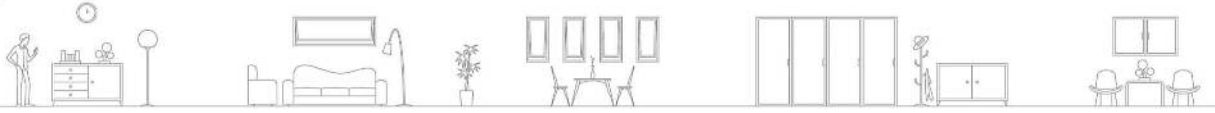

基本剖面圖

RC框型 YRB-A70 / 單拉窗B型 / 16mm溝寬

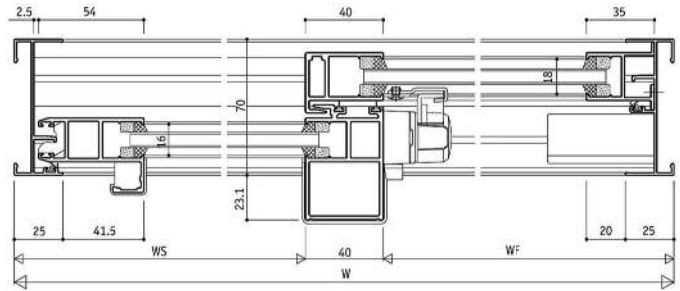
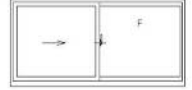
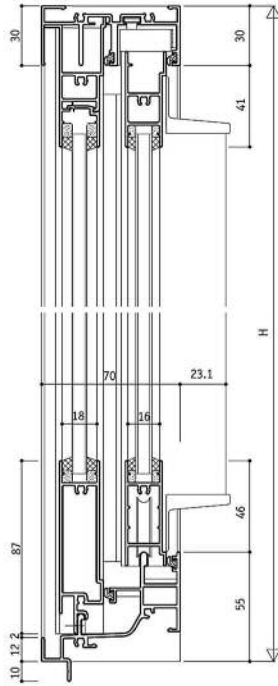

RC框型 YRB-A100 / 單拉窗D型 / 16mm溝寬

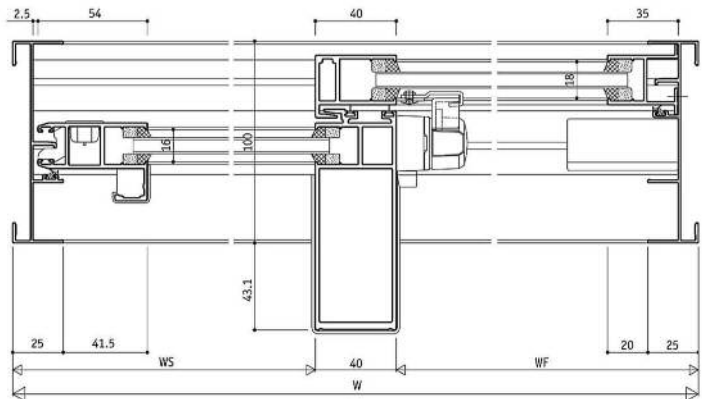
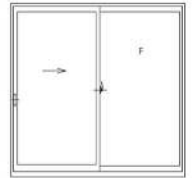
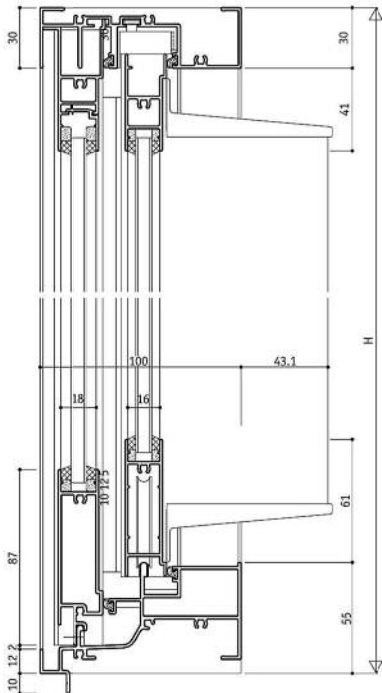



RC框型 YRB-A70 / 單拉窗B型 / 22mm溝寬

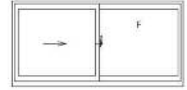
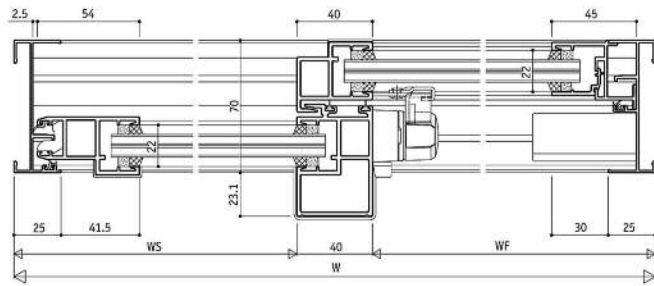
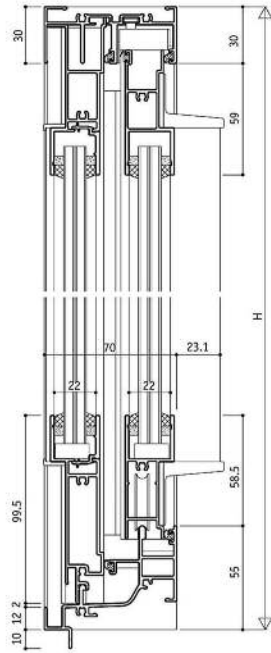

RC框型 YRB-A100 / 單拉窗D型 / 22mm溝寬

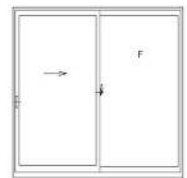
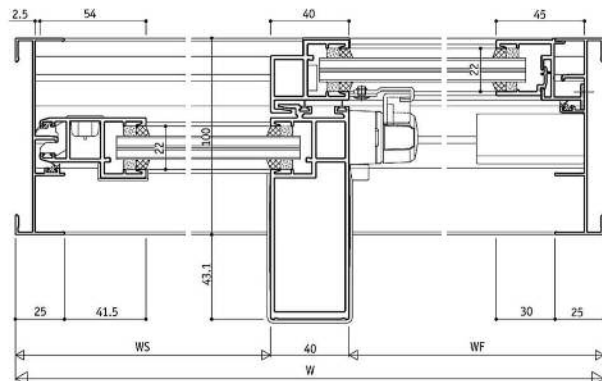
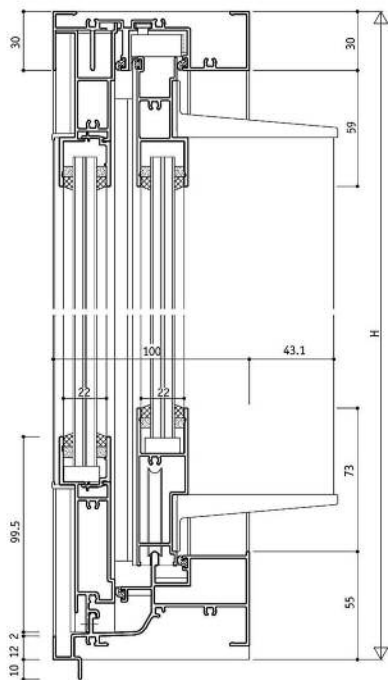

基本剖面圖

RC框型 YRB-A70 / 單拉窗B型 / 28mm溝寬

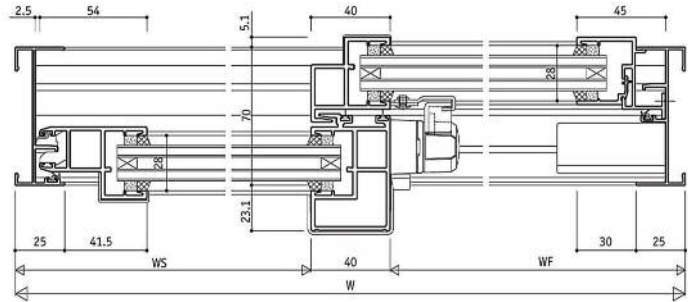
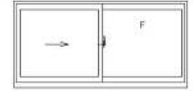
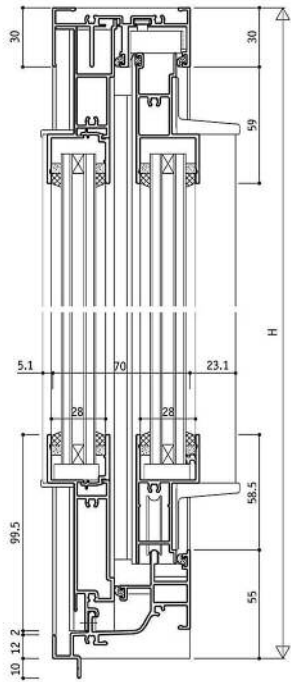

RC框型 YRB-A100 / 單拉窗D型 / 28mm溝寬

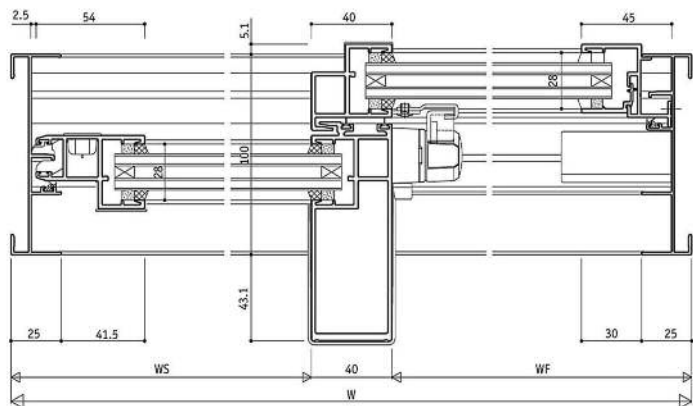
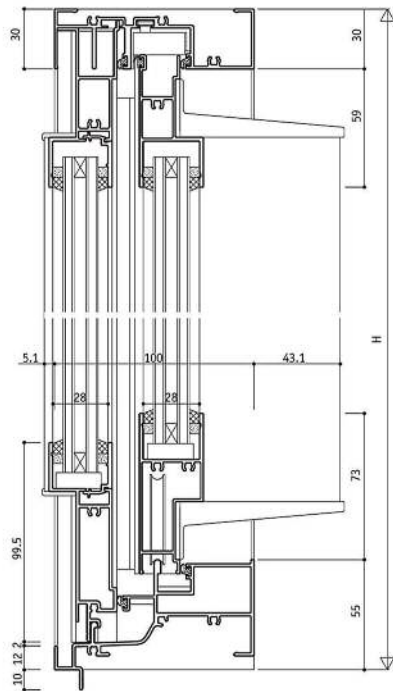

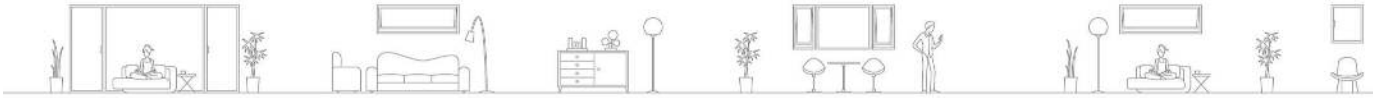

RC框型 YRB-A70 / 單拉窗B型 / 36mm溝寬

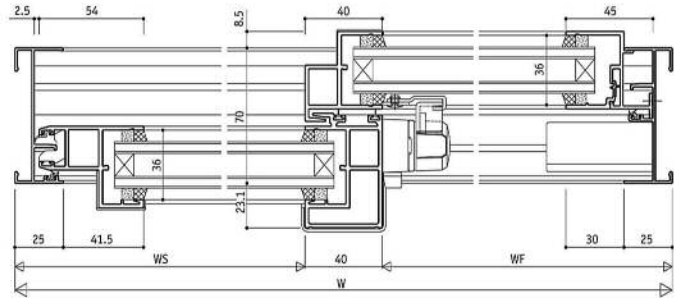
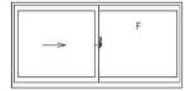
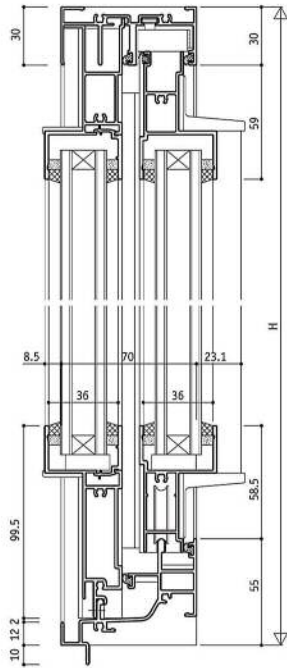

RC框型 YRB-A100 / 單拉窗D型 / 36mm溝寬

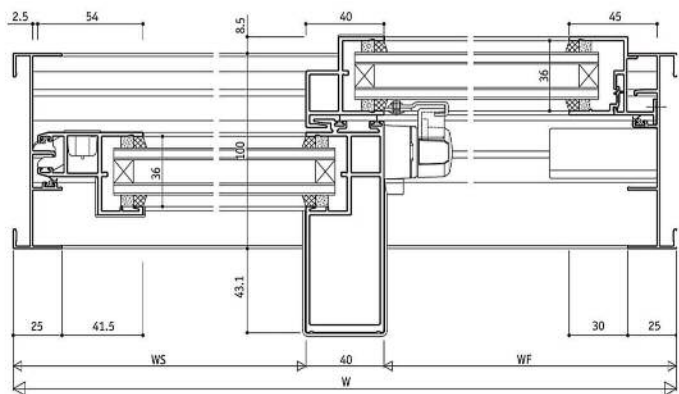
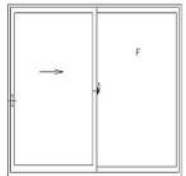
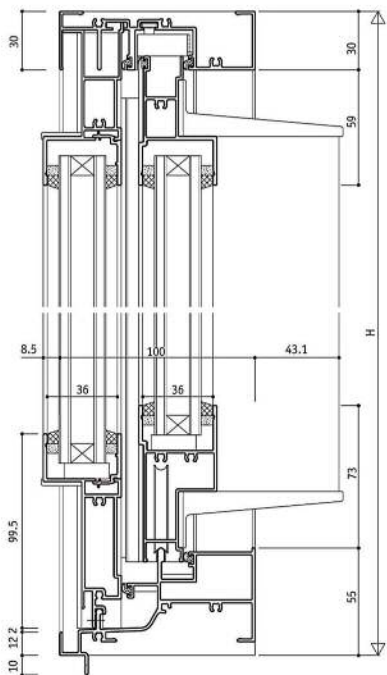

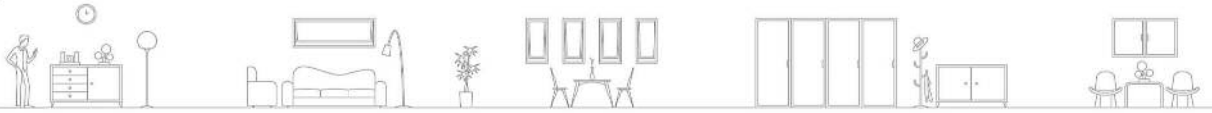

## 基本剖面圖

RC框型 YRB-A70 / 雙橫拉真固定B型 / 16mm溝寬

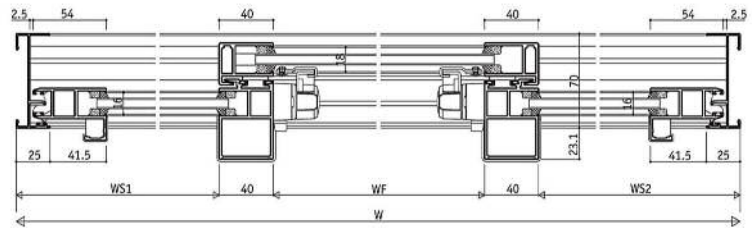
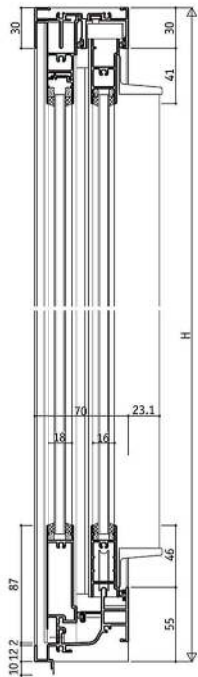

RC框型 YRB-A100 / 雙橫拉真固定D型 / 16mm溝寬

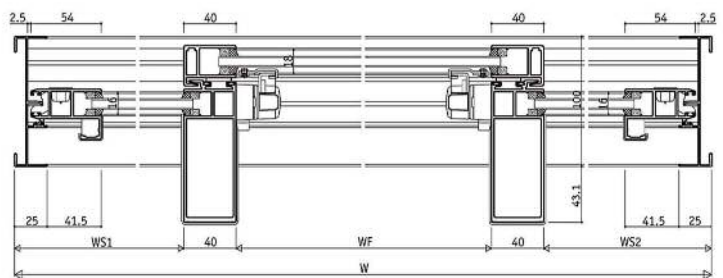
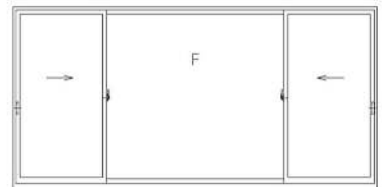
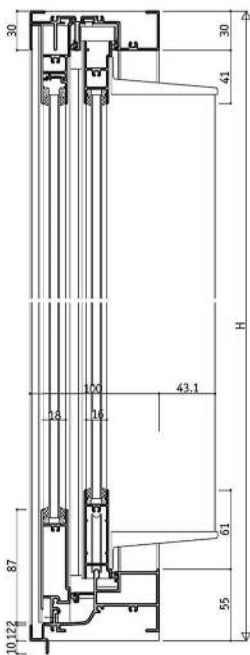

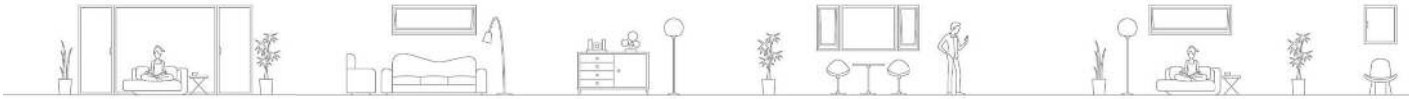

RC框型 YRB-A70 / 雙橫拉真固定B型 / 22mm溝寬

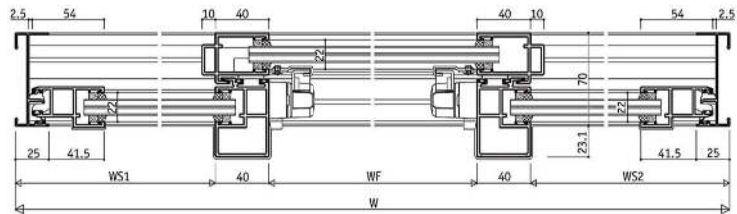
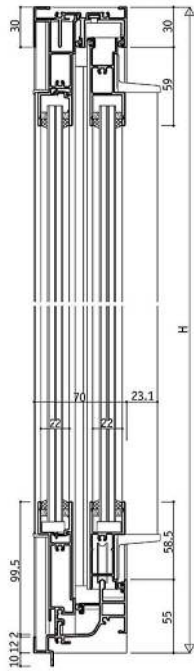

RC框型 YRB-A100 / 雙橫拉真固定D型 / 22mm溝寬

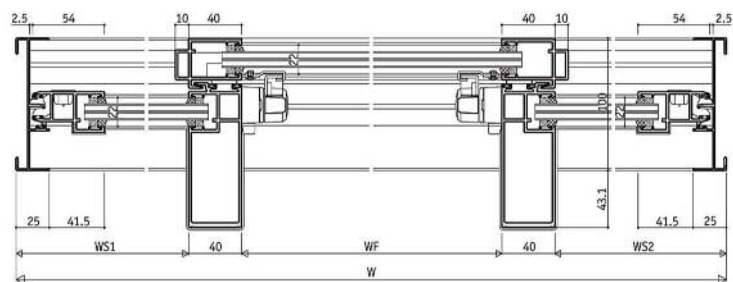
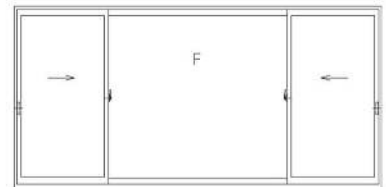
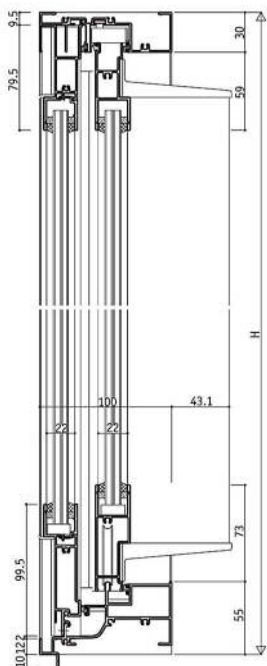

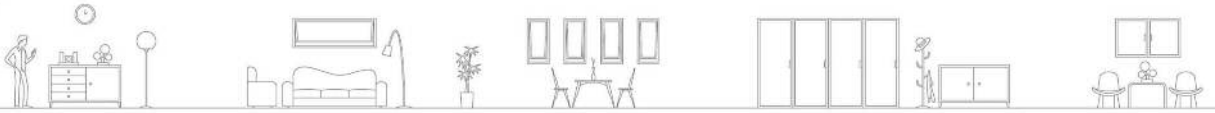

基本剖面圖

RC框型 YRB-A70 / 雙橫拉真固定B型 / 28mm溝寬

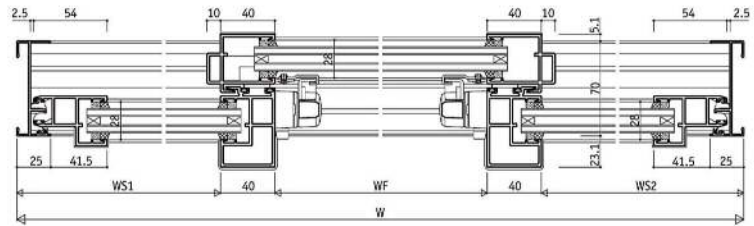
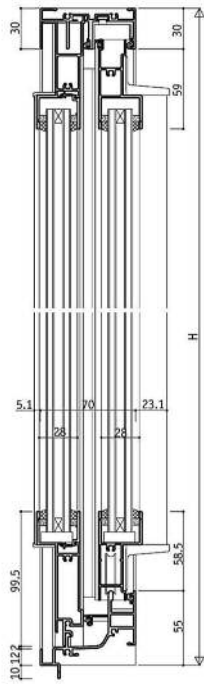

RC框型 YRB-A100 / 雙橫拉真固定D型 / 28mm溝寬

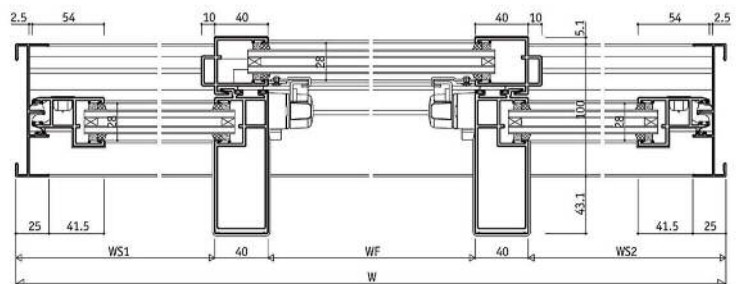
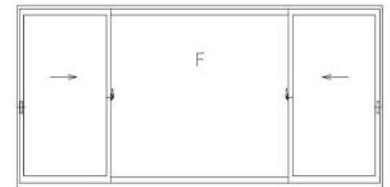
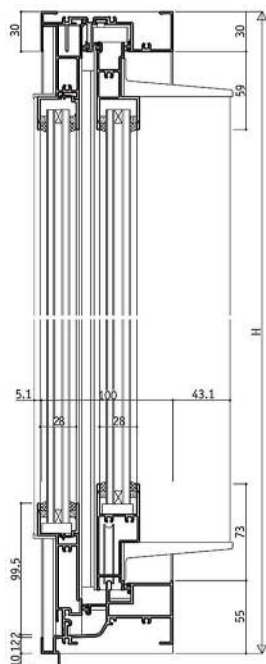

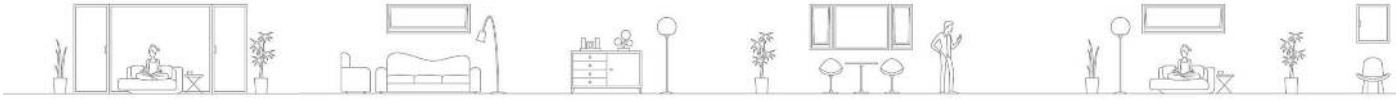

RC框型 YRB-A70 / 雙橫拉真固定B型 / 36mm溝寬

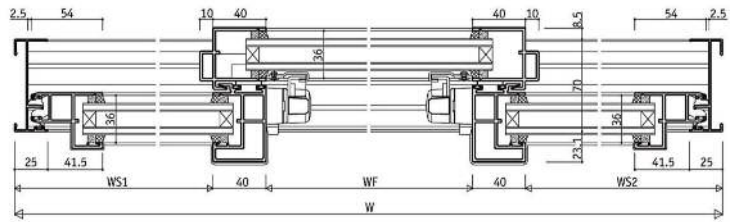
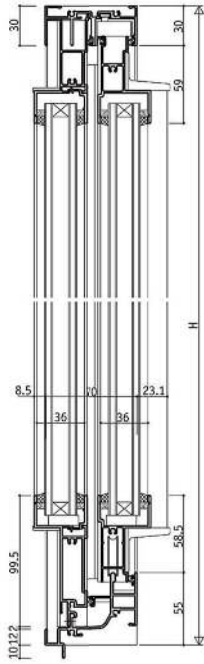

RC框型 YRB-A100 / 雙橫拉真固定D型 / 36mm溝寬

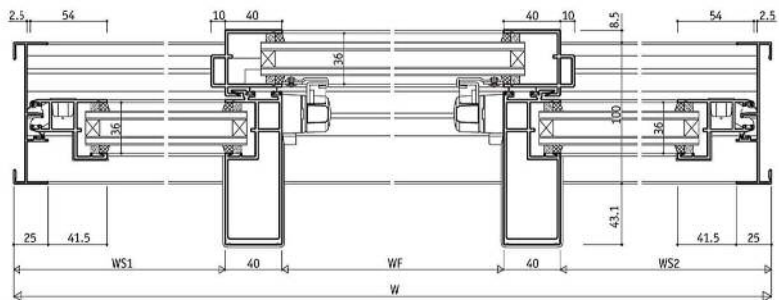
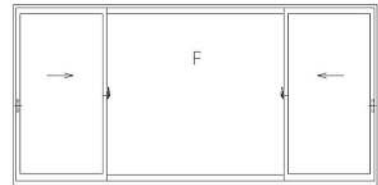
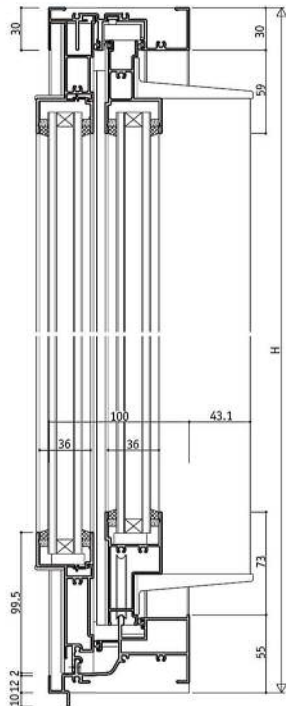

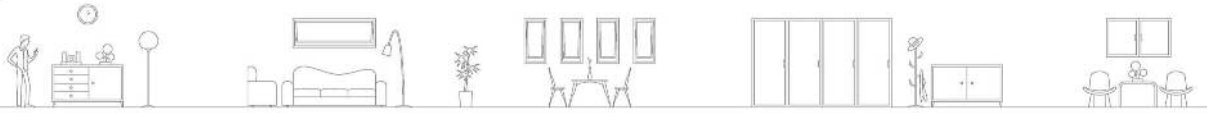

基本剖面圖

RC框型 YRB-A70 / 推開窗-單扣點式 / 18mm溝寬

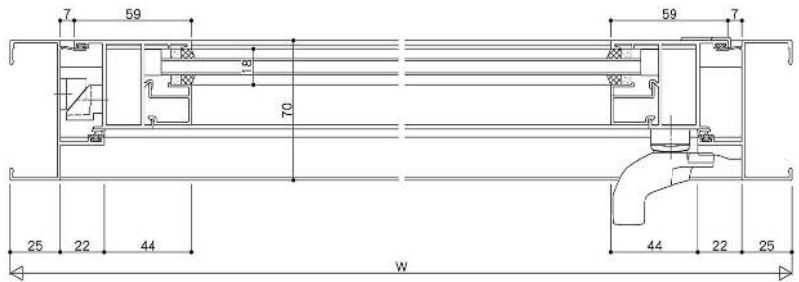
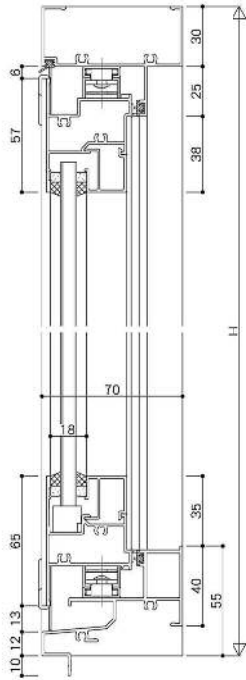

RC框型 YRB-A70 / 推開窗-單扣點式 / 22、28mm溝寬

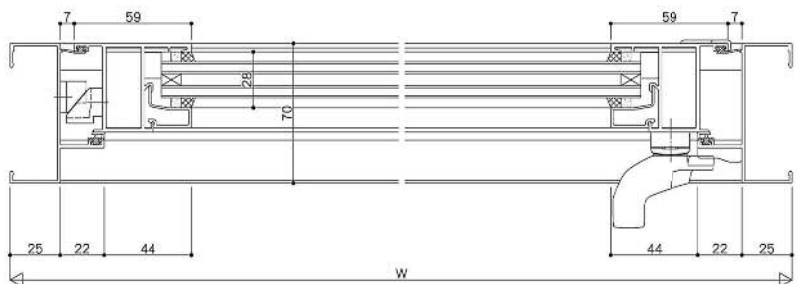
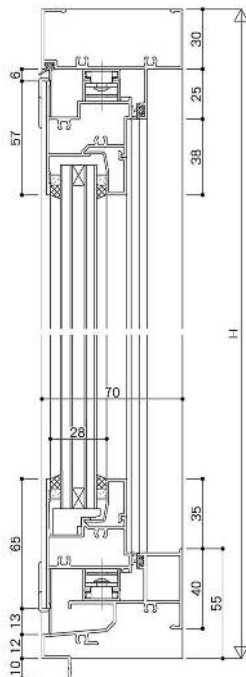



RC框型 YRB-A70 / 推開窗-連動扣點式 / 18mm溝寬

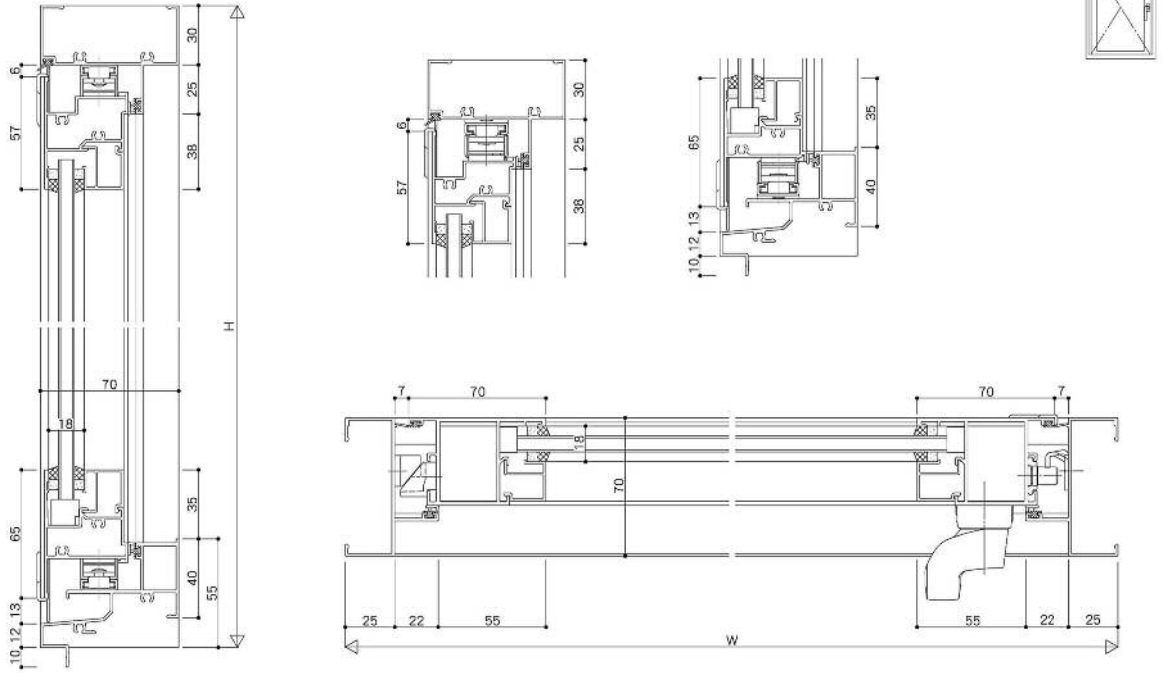

RC框型 YRB-A70 / 推開窗-連動扣點式 / 22、28mm溝寬

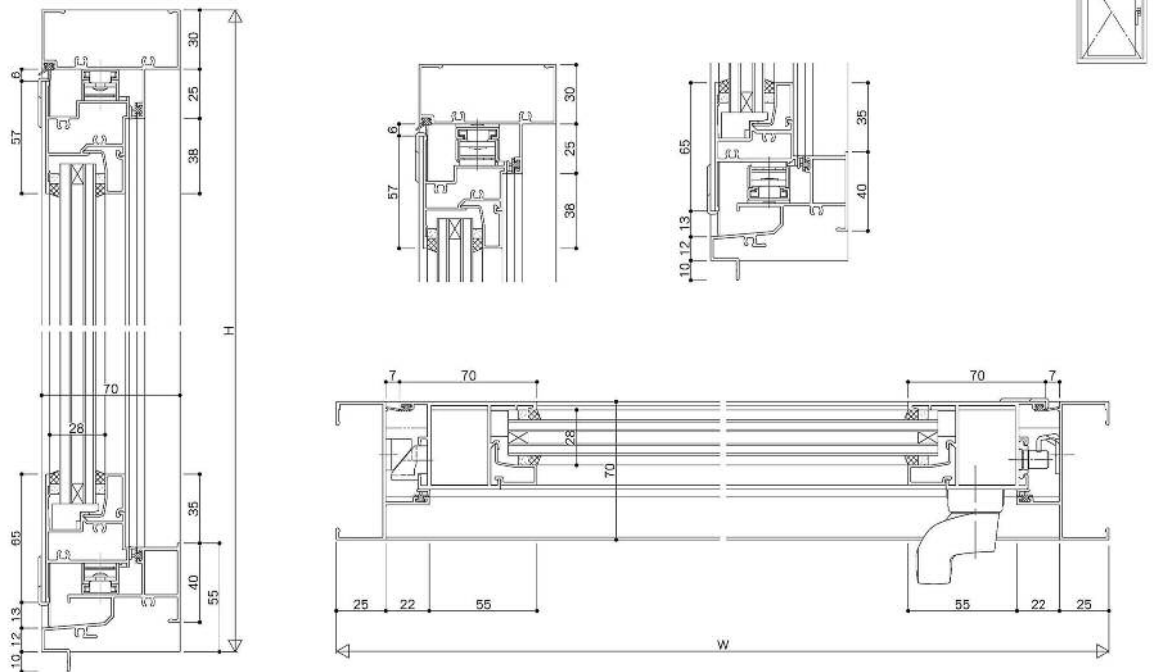

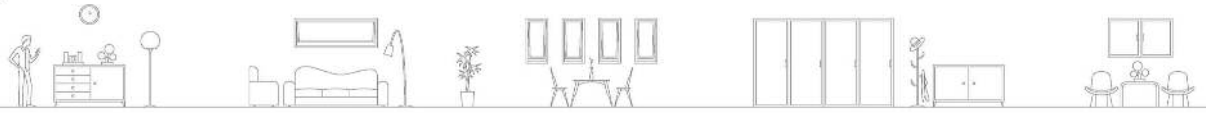

基本剖面圖

RC框型 YRB-A70 / 推射窗-單扣點式 / 18mm溝寬

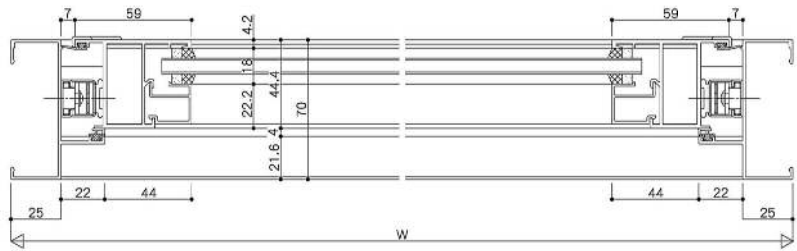
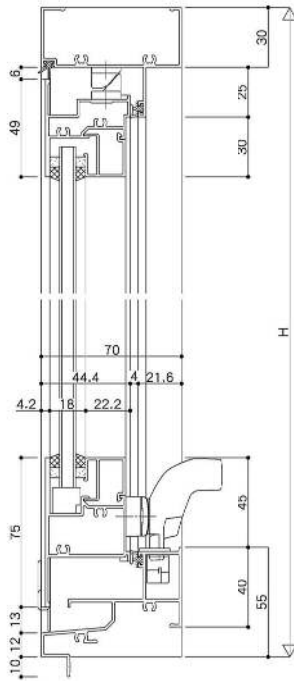

RC框型 YRB-A70 / 推射窗-單扣點式 / 22、28mm溝寬

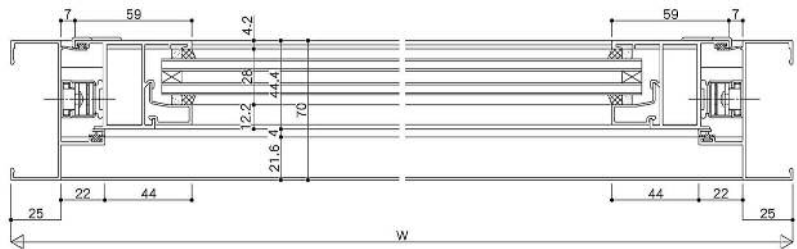
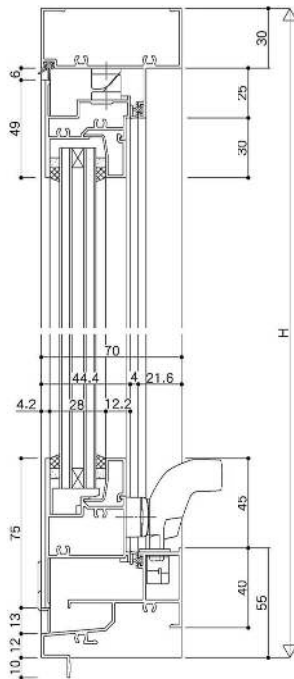

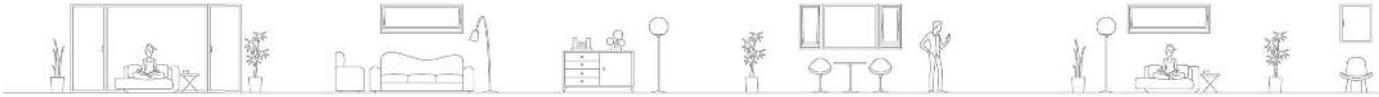

RC框型 YRB-A70 / 推射窗-連動扣點式 / 18mm溝寬.....

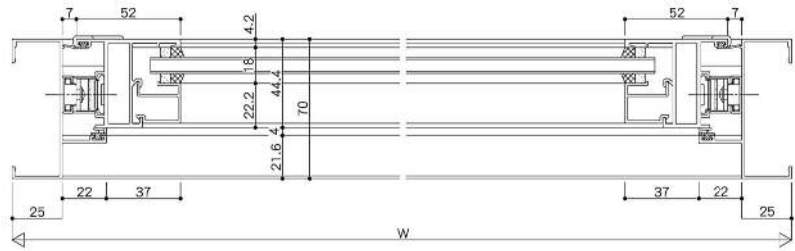
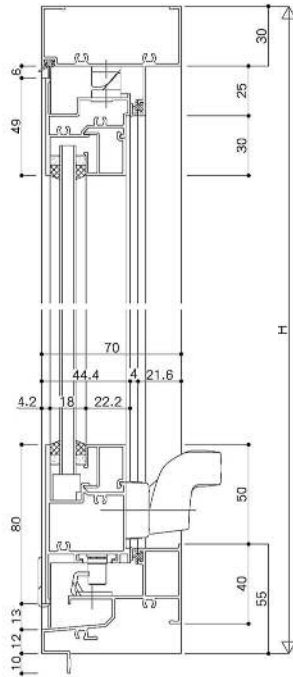

RC框型 YRB-A70 / 推射窗-連動扣點式 / 22、28mm溝寬.....

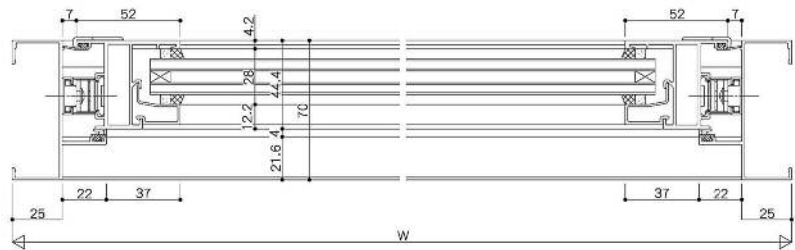
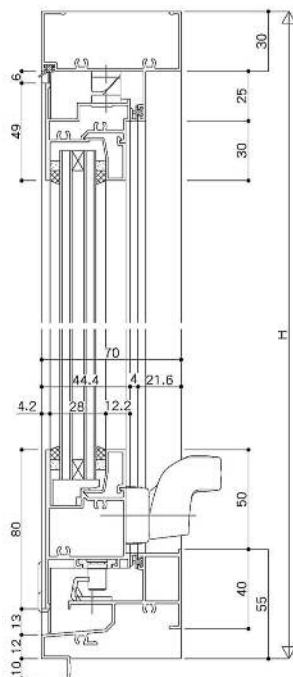

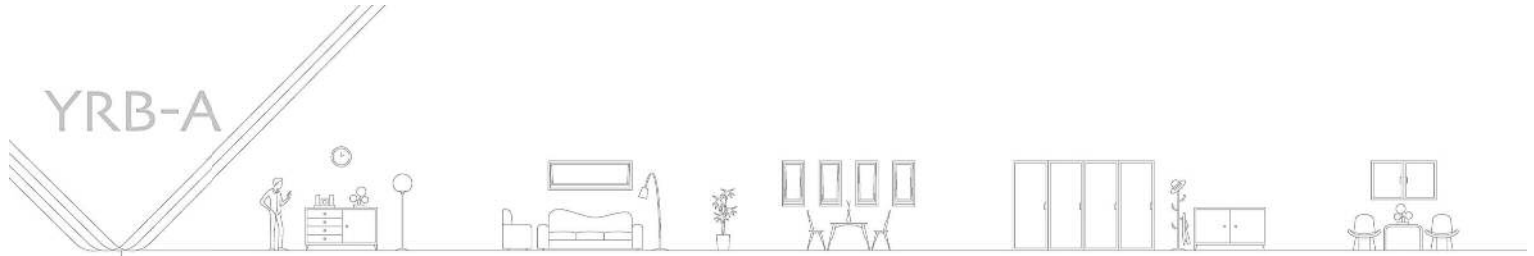

## 基本剖面圖

RC框型 YRB-A70 / 固定窗 / 18mm溝寬

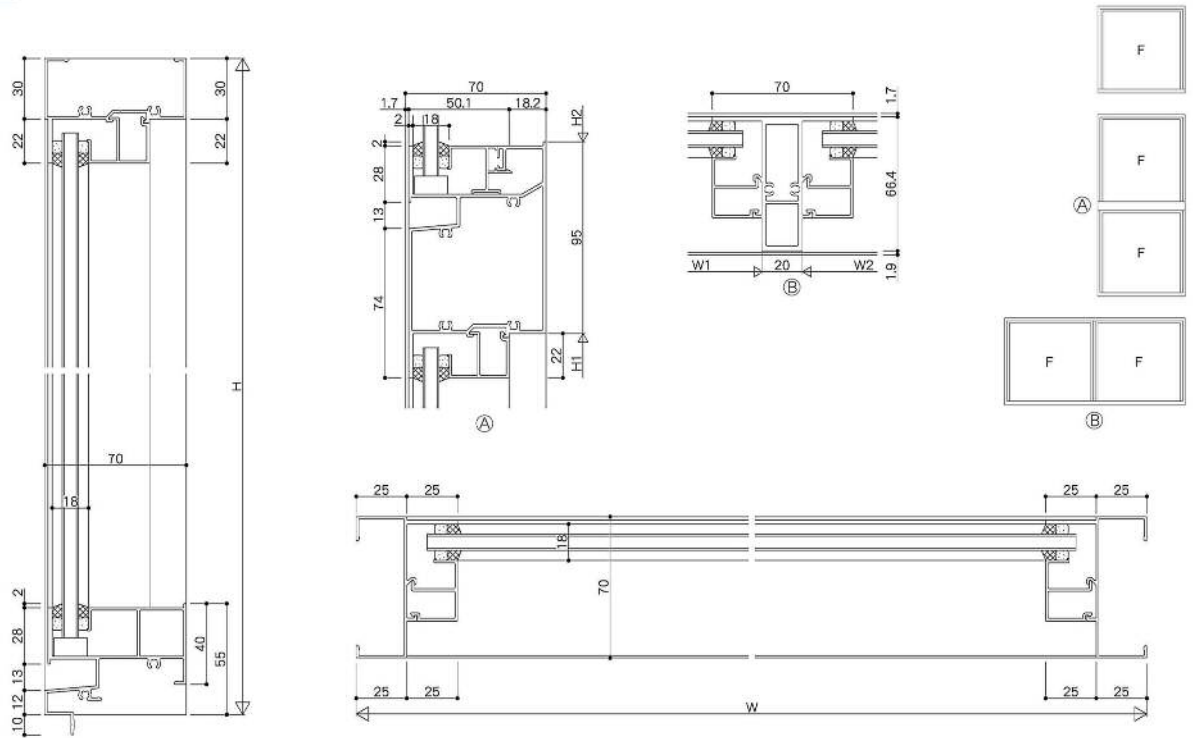

RC框型 YRB-A100 / 固定窗 / 18mm溝寬

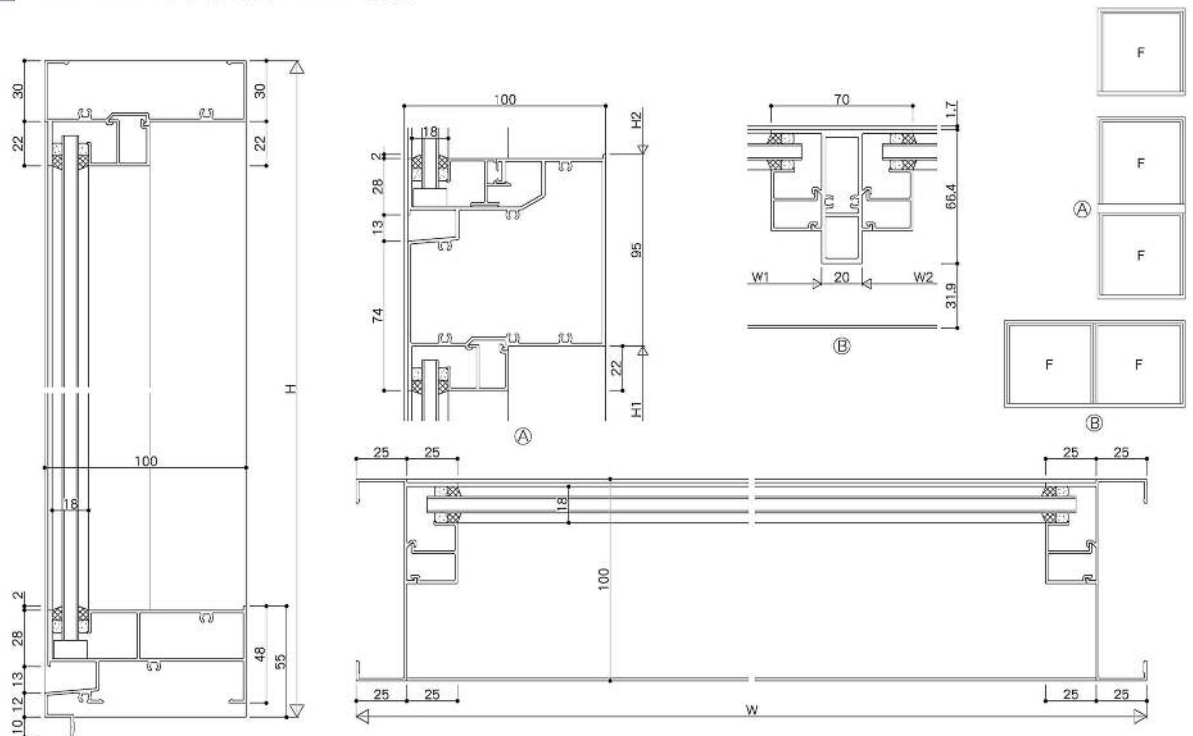

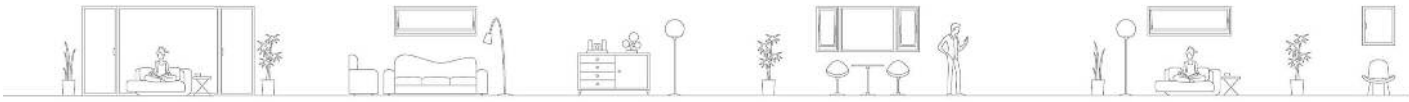

RC框型 YRB-A70/固定窗/28mm溝寬

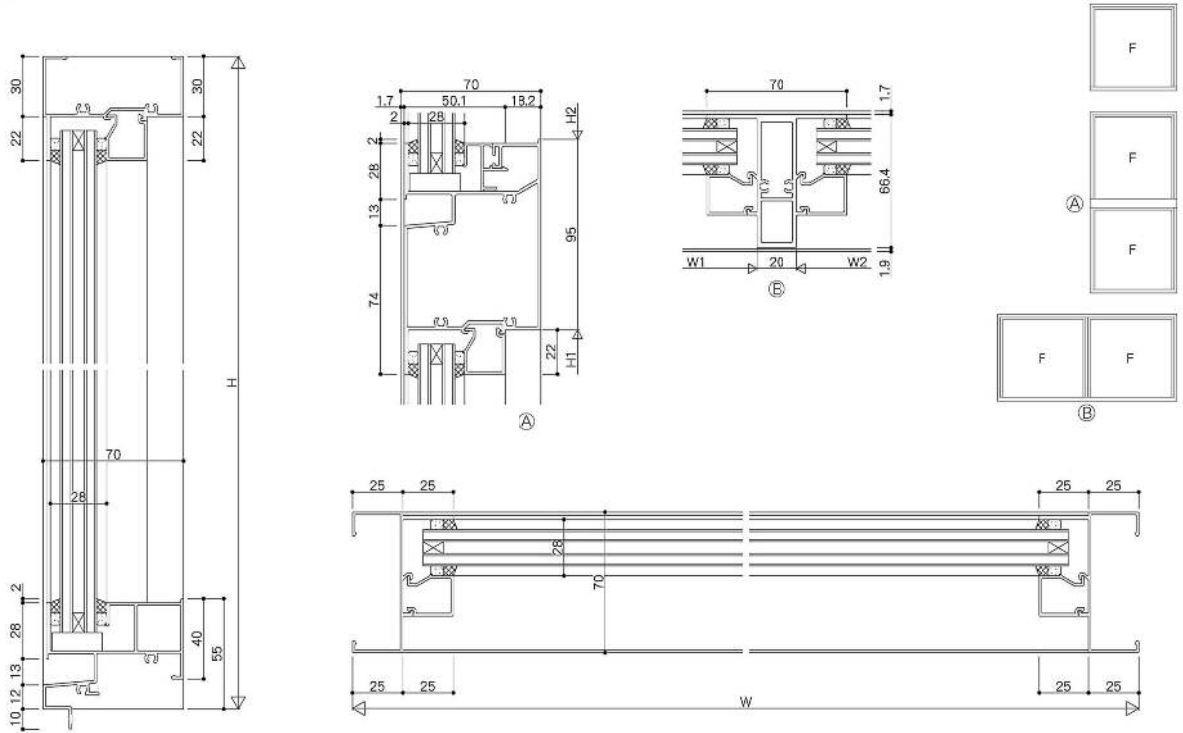

RC框型 YRB-A100/固定窗/28mm溝寬

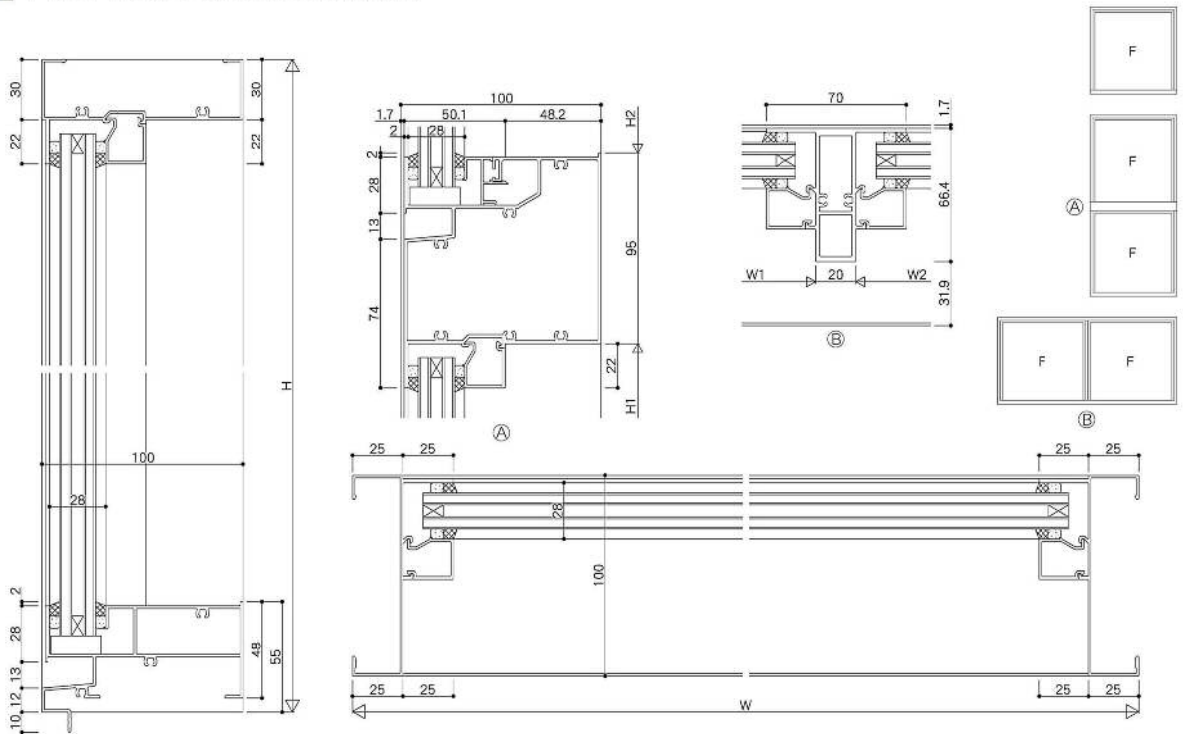



基本剖面圖

RC框型 YRB-A100 / 氣密門 / 18mm溝寬

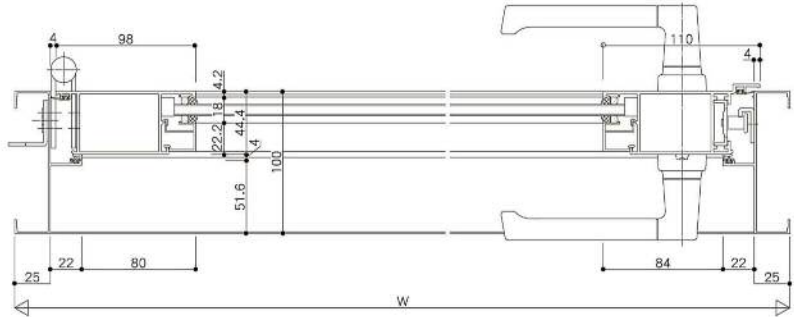
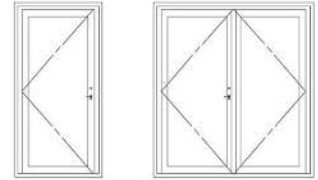
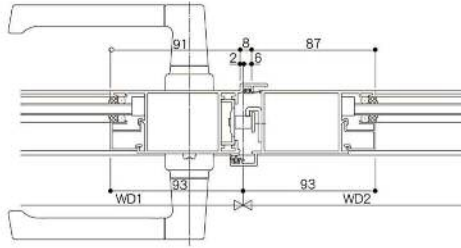
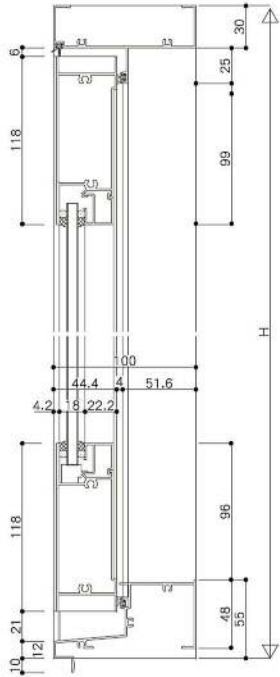

RC框型 YRB-A100 / 氣密門 / 22、28mm溝寬

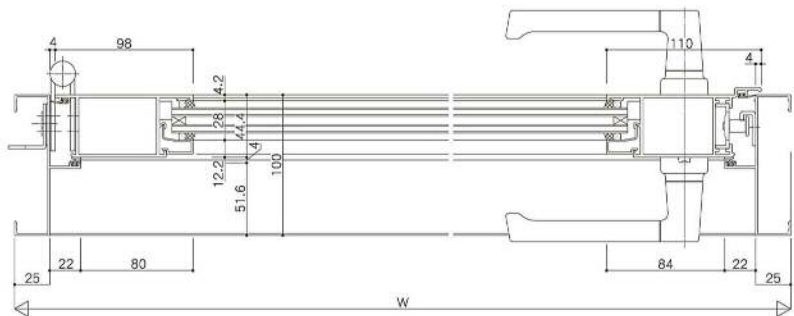
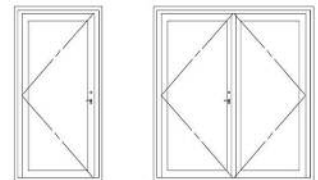
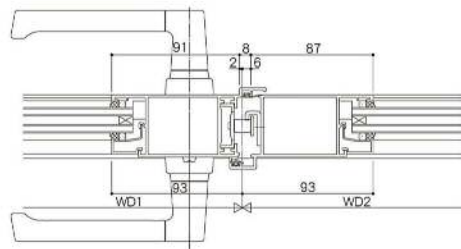
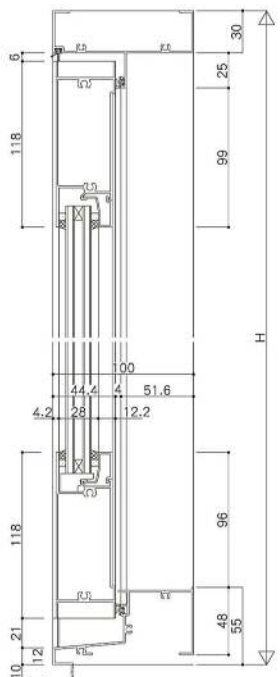





基本剖面圖

RC框型 YRB-A70 / 雙橫拉窗B型 / 16mm溝寬 / 外裝材：磁磚

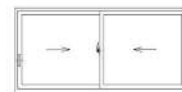
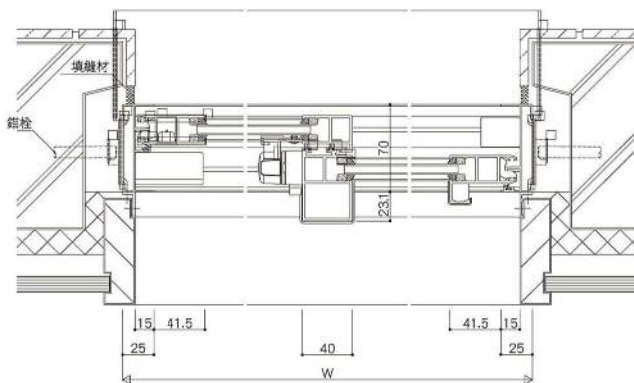
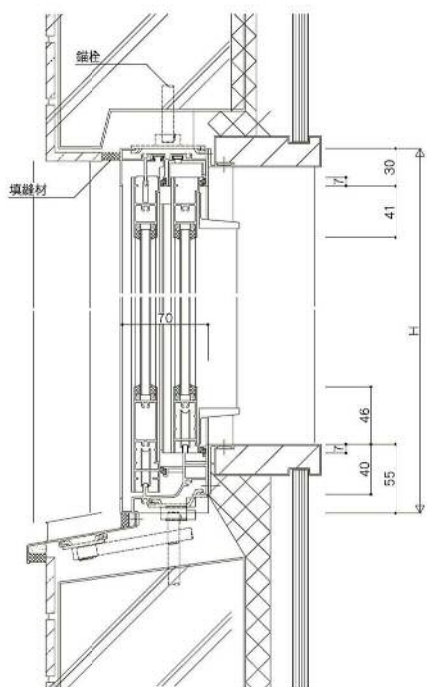

RC框型 YRB-A100 / 雙橫拉窗D型 / 16mm溝寬 / 外裝材：磁磚

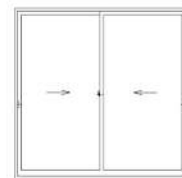
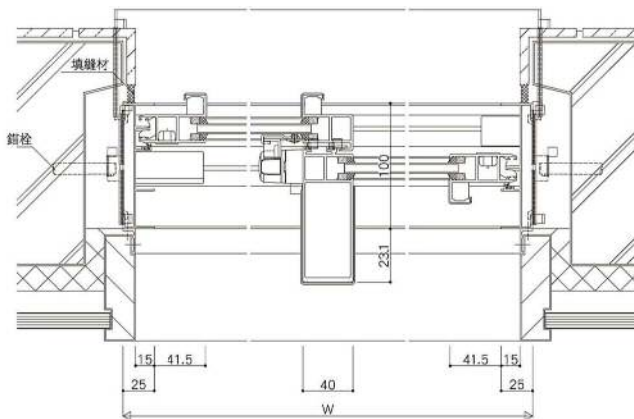
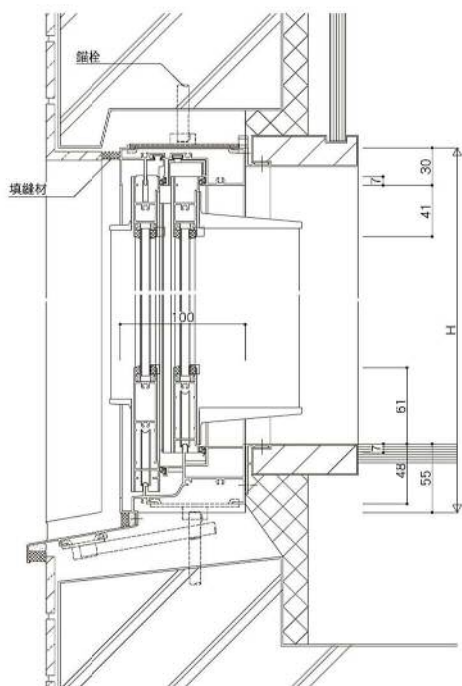

YRB-A.  
A d v a n c e



台灣 YKK 股份有限公司

建材事業部  
台北市民權東路二段40號 (YKK大樓)  
電話: (02)2511-5156  
傳真: (02)2571-2213

台中營業所  
台中市西屯區台灣大道二段633號4樓之5  
電話: (04)2310-1750  
傳真: (04)2310-1733

高雄營業所  
高雄市苓雅區四維三路6號25樓(A3)  
電話: (07)335-1869  
傳真: (07)335-9022

楊梅建材工廠  
桃園縣楊梅鎮楊新路三段3號  
電話: (03)478-6140  
傳真: (03)475-1031

2019年11月Printed in Taiwan